

# **BENGAL SCIENTIFIC GLASS INDUSTRIES**

## **Lab Glassware**

An ISO 9001-2008 Certified Company

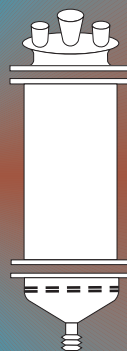
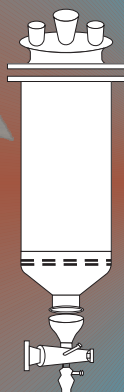
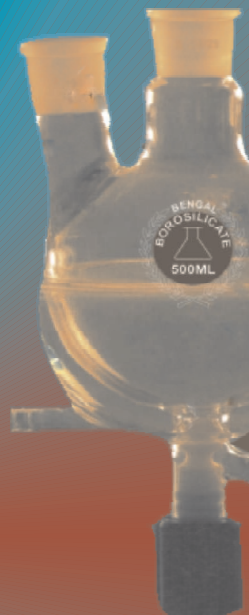

## **PRICE LIST**

**April, 2015**

Manufactured by :

### **BENGAL SCIENTIFIC GLASS INDUSTRIES**

Mfg. Off. : Unit No. 39, S Pratap Singh Indl. Estate-2, L.B.S. Marg, Bhandup (W), Mumbai-400 078. INDIA

Tel. : (022)-2566 5046 / 2566 9637, Mob. : 9869313962 / 8108030052

E-mail : bengalscientificglass@yahoo.co.in, Website : www.bengalscientificglass.com



**BENGAL Scientific Glass Industries**



PRODUCT RANGE	
	PAGES Nos.
1) ADAPTERS Reduction Expansion Multiple Cone, tubing Socket Tubing Air/Steam inlet tube Swan Neck Conical / Spherical Drying Tube Receiving Stillheads Splasheads Vacuum Adaptor Steam Distillation Cooling Miscellaneous	1 - 12
2) BEAKERS Micro Graduated	13 - 13
3) BOTTLES Dropping Reagents Screwcap Aspirator Specific Gravity Weighing Gas Washing TLC Glass bottle (Chamber)	14 - 18
4) BURETTES Straight bore Rotaflow key Double Oblique Bore PTFE Key Automatic Pressure Filling.	19 - 22
5) CONDENSERS Plain Liebig Double Surface Coil Bulb Graham Reflux Hopkin Cold Finger Ether Friedrichs Short Parth Distillation Drying Apparatus Vacuum	23 - 28
6) COLUMNS Plain Rotaflow Key Sintered Disc. Fractionating Vigreux Dufton Jacketed Tamping Rod Column with reservoir.	29 - 32
7) CYLINDER & DISHES Measuring Stoppered Spout Screw Cap Nessler Crow receivers Dishes Oil bath with coil	33 - 36
8) FLASKS Single Neck Two - Three Necks	37 - 48





PAGES Nos.		PAGES Nos.	
Kjehdahl Reaction Conical, Lid Jackted, SS Clip Shlenk Flasks Rotavap Filter Receiving Spherical Filter Iodine Pear Shape Distillation Volumetric Sulphonation		Micro Filter Assembly	
9) FUNNELS :	49 - 58	13) STIRRERS :	65 - 67
Filter Powder Separating Open top Dropping Pressing Equilising		Micro Link Collapsible Fix Paddle Anchor Mercury Seal Stuffing Box with brass pulley Syringe Stirrer	
10) GROUND JOINTS	59 - 60	14) STOPCOCKS	68 - 71
Conical Joints-Spherical Joints. etc.		Straight Bore Rotaflow P.T.F.E. T-Y-V Bore High Vacuum Three Limbs.	
11) PIPETTES :	61 - 62	15) STOPPERS - SPRAY	72 - 73
Volumetric Graduated Serological Pasture		Hollow Hexagonal Peny Head Solid Spray	
12) SINTEREDWARE :	63 - 64	16) TUBES :	74 - 78
Gooch Crucible Buchner Filter Funnel Filter Tubes Adapter Rods		Centrifuge Graduated Stopper Screwcap Melting Calcium chloride Tube connection T.Y.V. Sample tube Tube Absorption	

b





PAGES Nos.	PAGES Nos.
17) ASSEMBLIES : 79 - 85 Reflux Reaction Vacuum Distillation Soxhlet Extraction Kjeldahl Arsenic Freezing Point Vacuum Mainfold	Reflux Separator Bend T Adapters Stopcocks Drain Valves P.T.F.E. 'O' Ring & Gaskets Metal Flanges
18) P.T.F.E. PRODUCTS : 86 - 90 Mercury Seal Gas Wash Bottle Funnel Gas Sampling Bulb Screw Cap Policeman Bottles Mini Valves Magnetic Rotar Dishes Beakers Pulley	21) QUARTZ AND SILICA GLASS: 111 - 117 Beakers Crucibles Boats Basins Capsules Flask Funnel Ground Joints Plates Stopper Triangle
19) AMBER COLOUR PRODUCTS: 91 - 99 Burettes Cylinders Flasks Pipettes Separating Funnels Petridishes Bottles Beakers	22) HI-TECH GLASSWARE 118 - 123 Water Stills Desicators Vacuum Gauge Kipps App. Combustion Flask Manometers Amonia Condenser Filter Pump
20) PIPE LINE COMPONENTS: 100 - 110 Heat Exchangers Vessels Coloumns	23) METAL WARE: 124 - 127 Clamps Bossheads Spatulla, Stands Screw Clips, Jacks





PAGES Nos.	PAGES Nos.
Wire Gauge Watch Glass Brushes. Al test tube stand	
24) PORCELAIN WARE: 128 - 129	27) THERMOMETERS: 136 - 137
Basins Funnels Crucibles Mortar Pestle	Chemical Precision Long Immersion Ground Joints.
25) POLYTHENE WARE: 130 - 132	28) FILTER PAPER : 138
Beakers Bottles Cylinders Funnel Petridish Flask Burette Trays Tubes Desicators	Circles and Rim Watman No.1
26) RUBBER PRODUCTS 133 - 135	29) MISCELLANEOUS ITEMS: 139 - 140
Tubing Corks Bulbs Hand Gloves Bellows Pro Pipette Teats Adaptor	Buchi Clip Glass Syringe Needles for Syringe Canulla Neoprine Rubber Base ring High Vacuum grease Parafilm
	30) SEPTA 140

d





**ADAPTERS**

**1. REDUCTION ADAPTERS**

Cat No.	Socket	Cone	Price
1/1	10/19	14/23	185.00
1/2	10/19	19/26	195.00
1/3	14/23	19/26	205.00
1/4	14/23	24/29	230.00
1/5	14/23	29/32	260.00
1/6	19/26	24/29	295.00
1/7	19/26	29/32	260.00
1/8	19/26	34/35	315.00
1/9	19/26	45/40	455.00
1/10	19/26	55/44	485.00
1/11	24/29	29/32	275.00
1/12	24/29	34/35	295.00
1/13	24/29	40/38	355.00
1/14	24/29	45/50	385.00
1/15	24/29	55/44	510.00
1/16	29/32	34/35	420.00
1/17	29/32	45/40	495.00
1/18	29/32	60/46	845.00
1/19	34/35	45/40	520.00
1/20	34/35	55/44	665.00



1

**2. EXPANSION ADAPTERS**

Cat. No.	Socket	Cone	Price
2/1	14/23	10/19	195.00
2/2	19/26	14/23	230.00
2/3	24/29	14/23	215.00
2/4	24/29	19/26	220.00
2/5	29/32	14/23	350.00
2/6	29/32	19/26	285.00
2/7	29/32	24/29	295.00
2/8	34/35	19/26	295.00
2/9	34/35	24/29	325.00
2/10	34/35	29/32	380.00
2/11	45/40	24/29	445.00
2/12	34/40	29/32	470.00
2/13	45/40	34/35	555.00
2/14	55/44	34/35	745.00
2/15	55/44	45/40	865.00
2/16	60/46	29/32	895.00



2

\* PTFE ADAPTERS ALSO AVAILABLE





**ADAPTERS**

**3. MULTIPLE ADAPTERS TWO NECK PARALLEL**

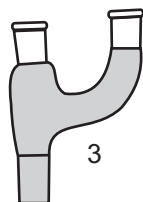

Cat. No.	Socket	Cone	Price
3/1	10/19	10/19	300.00
3/2	14/23	14/23	350.00
3/3	19/26	19/26	360.00
3/4	19/26	24/29	390.00
3/5	19/26	34/35	640.00
3/6	24/29	24/29	560.00
3/7	29/32	29/32	890.00

**4. MULTIPLE ADAPTERS TWO NECKS, ONE VERTICAL AND ONE AT ANGLE 45°**

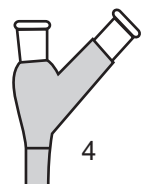

Cat No.	Socket	Cone	Price
4/1	19/26	19/26	350.00
4/2	19/26	24/29	390.00

**5. MULTIPLE ADAPTERS THREE NECKS TWO PARALLEL AND ONE AT ANGLE 45°**

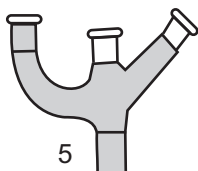

Cat No	Socket Parallel	Socket Angle	Cone	Price
5/1	14/23	14/23	19/26	380.00
5/2	19/26	14/23	24/29	600.00
5/3	19/26	19/23	24/29	610.00
5/4	19/26	19/26	29/32	630.00
5/5	19/26	19/26	34/35	735.00
5/6	19/26	19/26	55/44	1590.00

**6. CONETUBING ADAPTERS STRAIGHT CONNECTION**

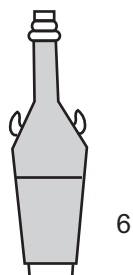

Cat No.	Cone	Price
6/1	10/19	175.00
6/2	14/23	195.00
6/3	19/26	190.00
6/4	24/29	210.00
6/5	29/32	240.00
6/6	34/35	340.00

2





**ADAPTERS**

**7. CONE TUBING ADAPTERS RIGHT ANGLE CONNECTION**

Cat No.	Cone	Price
7/1	10/19	175.00
7/2	14/23	195.00
7/3	19/26	190.00
7/4	24/29	210.00
7/5	29/32	240.00
7/6	34/35	340.00

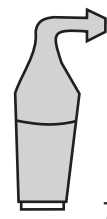

**8. SOCKET TUBING ADAPTERS STRAIGHT CONNECTION**

Cat No.	Socket	Price
8/1	14/23	195.00
8/2	19/26	190.00
8/3	24/29	210.00
8/4	29/32	240.00
8/5	34/35	340.00



**9. AIR/STEAM INLET TUBE BENT FOR STRAIGHT**

Cat No.	Cone	Stem Length mm	Price
9/1	07/16	100	210.00
9/2	10/19	100	210.00
9/3	14/23	150	210.00
9/4	19/26	150	240.00
9/5	24/29	150	270.00
9/6	29/32	150	340.00
9/7	34/35	200	490.00

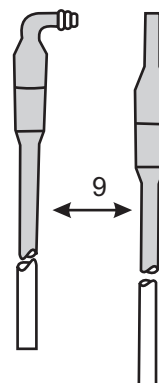

**10. SWAN NECK ADAPTERS FOR USE WITH THERMOMETER OR AIR LEAK TUBE**

Cat No.	Socket	Cone	Price
10/1	14/23	14/23	390.00
10/2	19/26	19/26	490.00
10/3	19/26	24/29	540.00
10/4	24/29	24/29	590.00



3







**ADAPTERS**

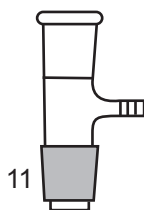

**11. SOCKET/CONE ADAPTERS WITH T CONNECTION**

Cat No.	Socket	Cone	Price
11/1	14/23	14/23	270.00
11/2	14/23	19/26	290.00
11/3	14/23	24/29	320.00
11/4	19/26	19/26	340.00
11/5	19/26	24/29	360.00
11/6	19/26	29/32	440.00
11/7	19/29	34/35	570.00
11/8	24/29	24/29	440.00
11/9	29/32	29/32	640.00
11/10	34/35	34/35	690.00



**12. CONICAL/SPHERICAL ADAPTERS SOCKET TO BALL**

Cat No.	Socket	Cone	Price
12/1	19/26	S 29	790.00
12/2	24/29	S 35	840.00



**13. CONICAL / SPHERICAL ADAPTERS CONE TO CUP**

Cat No.	Socket	Cone	Price
13/1	19/26	S 29	790.00
13/2	24/29	S 35	840.00



**14. DRYING TUBE ANGLED**

Cat No.	Cone	Price
14/1	10/19	210.00
14/2	14/23	230.00
14/3	19/26	250.00
14/4	24/29	300.00
14/5	29/32	350.00
14/6	34/35	510.00





**ADAPTERS**

**15. RECEIVING ADAPTERS PLAIN BEND SHORT**

Cat No.	Socket	Price
15/1	10/19	195.00
15/2	14/23	210.00
15/3	19/26	230.00
15/4	24/29	250.00
15/5	29/32	230.00
15/6	34/35	410.00

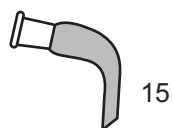

**16. RECEIVING ADAPTERS PLAIN BEND LONG**

Cat No.	Socket	Price
16/1	10/19	195.00
16/2	14/23	210.00
16/3	19/26	230.00
16/4	24/29	250.00
16/5	29/32	230.00
16/6	34/35	410.00

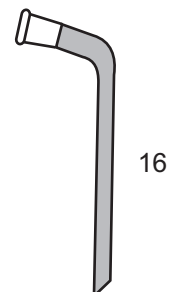

**17. RECEIVING ADAPTERS STRAIGHT DELIVERY**

Cat No.	Socket	Price
17/1	10/19	195.00
17/2	14/23	210.00
17/3	19/26	230.00
17/4	24/29	250.00
17/5	29/32	230.00
17/6	34/35	410.00



**18. RECEIVING ADAPTERS BEND SOCKET TO CONE**

Cat No.	Socket	Cone	Price
18/1	10/19	10/19	270.00
18/2	14/23	14/23	300.00
18/3	19/26	19/26	350.00
18/4	19/26	24/29	370.00
18/5	24/29	24/29	460.00
18/6	29/32	29/32	450.00
18/7	34/35	34/35	750.00

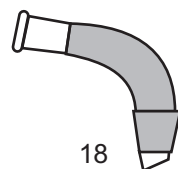



**ADAPTERS**

**19. RECEIVING ADAPTERS BEND WITH VENT**

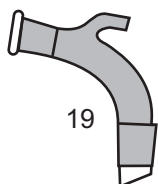

Cat No.	Socket	Cone	Price
19/1	10/19	10/19	290.00
19/2	14/23	14/23	320.00
19/3	19/26	19/26	390.00
19/4	19/26	24/29	410.00
19/5	24/29	24/29	440.00
19/6	29/32	29/32	450.00
19/7	34/35	34/35	780.00

**20. VACUUM ADAPTERS BEND**

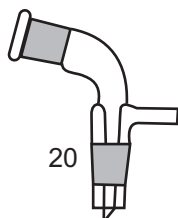

Cat No.	Socket	Cone	Price
20/1	10/19	10/19	410.00
20/2	14/23	14/23	320.00
20/3	19/26	19/26	370.00
20/4	19/26	24/29	410.00
20/5	24/29	24/29	460.00
20/6	29/32	29/32	580.00
20/7	34/35	34/35	780.00

**21. VACUUM ADAPTERS STRAIGHT**

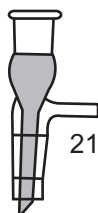

Cat No.	Socket	Cone	Price
21/1	19/26	19/26	370.00
21/2	19/26	24/29	410.00
21/3	24/29	24/29	460.00

**22. BEND MULTIPLE CONNECTION (PIG)**



Cat No.	Socket	Cone	Price
22/1	10/19	10/19	1090.00
22/2	14/23	14/23	1140.00
22/3	19/26	14/23	1240.00
22/4	24/29	14/23	1340.00
22/5	29/32	14/23	1390.00





**ADAPTERS**

**23. PERKIN INTERMEDIATE RECEIVER**

Cat No.	Socket	Cone	Cap ml	Price
23/1	14/23	14/23	10	2990.00
23/2	19/26	19/26	32	3990.00
23/3	19/26	24/29	32	3990.00
23/4	24/29	24/29	32	3990.00
23/5	34/35	34/35	100	7990.00

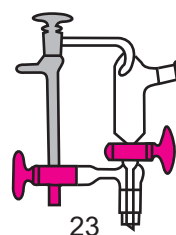

23

**24. RECEIVING ADAPTER SLOPING DELIVERY**

Cat No.	Socket	Cone	Price
24/1	19/26	19/26	490.00

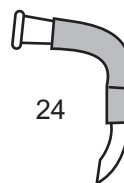

24

**25. RECEIVING ADAPTERS VERTICAL DELIVERY**

Cat No.	Socket	Cone	Price
25/1	19/26	19/26	490.00

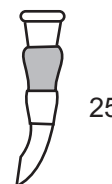

25

**26. RECEIVING ADAPTERS VACUUM WITH 4 CONNECTIONS**

Cat No.	Socket	Cone	Price
26/1	19/26	14/23	1490.00



26

**27. RECOVERY BEND SLOPING (ELBOW)**

Cat No.	Flask Cone	Cond. Cone	Price
27/1	14/23	14/23	240.00
27/2	19/26	19/26	290.00
27/3	24/29	19/26	320.00
27/4	24/29	24/29	340.00
27/5	29/32	29/32	360.00
27/6	29/32	29/32	350.00
27/7	34/34	19/26	450.00
27/8	34/35	24/29	480.00
27/9	34/35	34/35	700.00

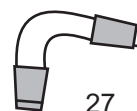

27





**ADAPTERS**

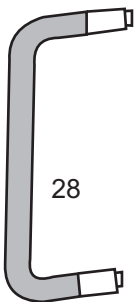

**28. RECOVERY BEND VERTICAL**

Cat No.	Flask Cone	Cond. Cone	Price
28/1	14/23	14/23	350.00
28/2	19/26	19/26	380.00
28/3	24/29	29/26	490.00
28/4	24/29	24/29	470.00
28/5	34/35	34/35	1090.00

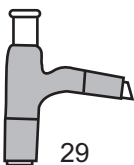

**29. PLAIN STILL HEAD SLOPING**

Cat No.	Flask Cone	Cond. Cone	Socket	Price
29/1	10/19	10/19	10/19	330.00
29/2	14/23	14/23	14/23	390.00
29/3	19/26	19/26	14/23	340.00
29/4	19/26	19/26	19/26	575.00
29/5	24/29	19/26	14/23	420.00
29/6	24/29	24/29	14/23	440.00
29/7	29/32	19/26	14/23	450.00
29/8	29/32	29/32	14/23	470.00
29/9	34/35	19/26	14/23	690.00
29/10	34/35	24/29	14/23	630.00
29/11	34/35	34/35	14/23	760.00

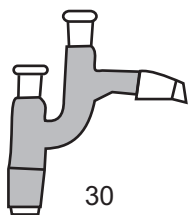

**30. CLAISEN HEAD SLOPING**

Cat No.	Flask Cone	Cond. Cone	Socket	Price
30/1	14/23	14/23	14/23	550.00
30/2	19/26	19/26	14/23	590.00
30/3	24/29	19/26	14/23	640.00
30/4	24/29	24/29	14/23	650.00
30/5	29/32	29/32	14/23	750.00
30/6	34/35	29/32	14/23	950.00





**ADAPTERS**

**31. SPLASH HEAD ADAPTERS**

Cat No.	Flask Cone	Cond Cone	Price
31/1	19/26	19/26	460.00
31/2	24/29	19/26	480.00
31/3	24/29	24/29	550.00
31/4	24/29	19/26	625.00
31/5	29/32	29/32	655.00
31/6	34/35	19/26	700.00
31/7	34/35	24/29	760.00
31/8	34/35	34/35	850.00

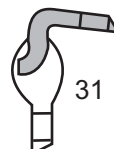

**32. SPLASH HEAD PEAR SHAPE VERTICAL**

Cat No.	Flask Cone	Cond Cone	Price
32/1	19/26	19/26	550.00
32/2	24/29	19/26	600.00
32/3	24/29	24/29	680.00
32/4	34/35	24/29	780.00

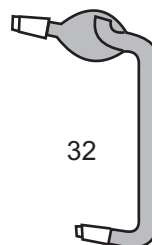

**33. STEAM DISTILLATION HEAD SLOPING**

Cat No.	Flask Cone	Cond Cone	Price
33/1	24/29	19/26	890.00
33/2	34/35	29/26	900.00
33/3	34/35	24/29	980.00



**34. SPLASH HEAD SLOPING DOUBLE BULB**

Cat No.	Flask Cone	Cond Cone	Socket	Price
34/1	24/29	19/26	14/23	1990.00



**35. SPLASH HEAD ANTI FOAMING SLOPING**

Cat No.	Flask Cone	Cond. Cone	Socket	Price
35/1	24/29	19/26	14/23	3590.00

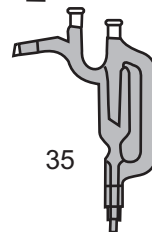



**ADAPTERS**



36

**36. SPLASH HEAD VERTICAL**

Cat No.	Socket	Cone	Price
36/1	19/26	24/29	530.00
36/2	24/29	24/29	565.00

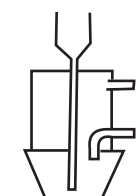

37

**37. COOLING ADAPTER WITH CONE**

Cat No.	Cone	Price
37/1	29/32	1490.00
37/2	34/35	1690.00
37/3	45/40	1990.00
37/4	60/46	2890.00
37/5	70/50	3990.00

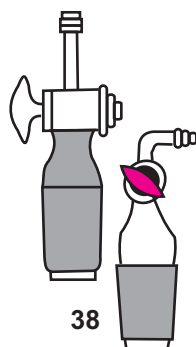

38

**38. CONE / ADAPTER TUBE CONNECTION WITH STOPCOCK (STRAIGHT OR BENT)**

Cat No.	Cone	Price
38/1	14/23	375.00
38/2	19/26	375.00
38/3	24/29	410.00
38/4	29/32	4150.00
38/5	34/35	465.00

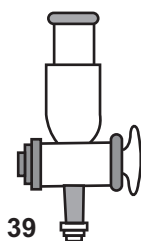

39

**39. SOCKET / ADAPTER TUBE CONNECTION WITH STOPCOCK (STRAIGHT OR BENT)**

Cat No.	Socket	Price
39/1	14/23	375.00
39/2	19/26	375.00
39/3	24/29	410.00
39/4	29/32	415.00
39/5	34/35	465.00





**ADAPTERS**

**40. STOPCOCK SOCKET TO CONE**

Cat No.	Socket	Cone	Price
40/1	14/23	14/23	690.00
40/2	19/26	19/26	740.00
40/3	24/29	24/29	840.00
40/4	29/32	29/32	1090.00
40/5	34/35	34/35	1340.00

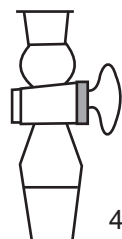

40

**41. VACUUM CONTROL STOPCOCK**

Cat No.	Cone	Price
41/1	19/26	1090.00
41/2	24/29	1190.00

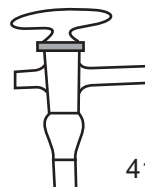

41

**42. VACUUM RELEASE STOPCOCK**

Cat No.	Cone	Price
42/1	19/26	1090.00
42/2	24/29	1190.00

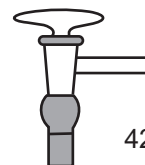

42

**43. FIXED IMMERSION THERMOMETER POCKET**

Cat No.	Cone	Stem Length mm	Price
43/1	14/23	45	210.00
43/2	14/23	200	230.00
43/3	14/23	400	260.00
43/4	19/26	200	280.00
43/5	19/26	400	270.00
43/6	24/29	300	300.00
43/7	34/35	400	380.00



43

**44. REFLUX RATIO HEAD (UNIVERSAL)**

Cat No.	Socket Cone	Thermo-meter Socket	Ball joint	Price
44/1	24/29	14/23	S19	8990.00
44/2	34/35	14/23	S29	9990.00
44/3	55/44	19/26	S35	1159.00

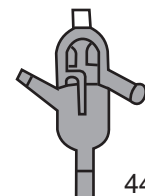

44







**ADAPTERS**

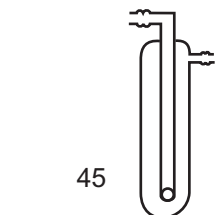

**45. VACUUM TRAP THICK WALL**

Cat No.	Dia mm	Price Single	Price Double
45/1	30	690.00	1900.00
45/2	50	955.00	3710.00



**46. CONE SCREW THREAD ADAPTERS STRAIGHT**

Cat No.	Tube dia mm	Cone	Acceptable dia through screw cap mm	Price
46/1	15	14/23	7	690.00
46/2	15	19/26	7	740.00
46/3	15	24/29	7	790.00
46/4	15	29/32	7	890.00
46/5	25	29/26	11	940.00
46/6	25	24/29	11	990.00
46/7	25	29/32	11	1040.00
46/8	25	34/35	11	1090.00

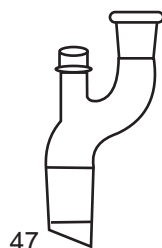

**47. SWAM NECK ADAPTERS FOR THERMOMETERS AIR LEAK TUBE WITH SCREW THREAD**

Cat No.	Tube Dia mm	Socket	Cone	Price
47/1	15	14/23	14/23	890.00
47/2	15	19/26	19/26	940.00
47/3	15	19/26	24/29	1040.00
47/4	15	24/29	24/29	1140.00

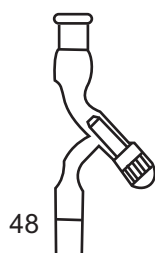

**48. ADAPTERS P.T.E.F. SCREW COCK**

Cat No.	Socket	Cone	Price
48/1	19/26	19/26	940.00
48/2	19/26	24/29	940.00
48/3	24/29	24/29	1220.00
48/4	29/32	29/32	1330.00
48/5	34/35	34/35	1640.00





**BEAKERS**

**49. BEAKERS LOW FORM WITH SPOUT**

Cat No.	Cap. ml.	Price
49/1	1-5	85.00
49/2	10	90.00
49/3	25	100.00
49/4	50	80.00
49/5	100	90.00
49/6	150	100.00
49/7	250	95.00
49/8	400	165.00
49/9	500	155.00
49/10	600	170.00
49/11	1000	300.00
49/12	2000	600.00
49/13	3000	1500.00
49/14	5000	2150.00
49/15	10000	7300.00

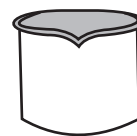

49

**50. BEAKERS TALL FORM WITH OR WITHOUT SPOUT**

Cat No.	Cap. ml.	Price
50/1	25	165.00
50/2	50	220.00
50/3	100	250.00
50/4	250	280.00
50/5	500	300.00
50/6	1000	430.00

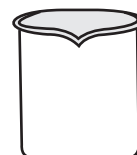

50





**BOTTLES**

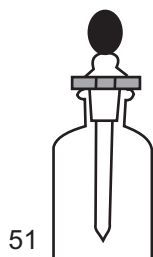

51

**51. BOTTLES DROPPING WITH PIPETTE AND RUBBER TEAT**

Cat No.	Cap. ml.	Joint	Price
51/1	30	14/23	390.00
51/2	60	14/23	490.00
51/3	125	19/26	590.00



52

**52. BOTTLES DROPPING WITH GRADUATED PIPETTE AND RUBBER TEAT**

Cat No.	Cap. ml.	Joint	Price
52/1	30	14/23	490.00
52/2	60	14/23	390.00
52/3	125	19/27	640.00



53

**53. BOTTLES DROPPING WITH GROOVED STOPPER T.K. PATTERN**

Cat No.	Cap. ml.	Joint	Price
53/1	30	14/23	690.00
53/2	60	14/23	740.00
53/3	125	19/26	890.00



54

**54. BOTTLES REAGENT NARROW MOUTH WITH HOLLOW INTERCHANGEABLE STOPPER**

Cat No.	Cap. ml.	Joint	Price
54/1	30	14/23	390.00
54/2	60	14/23	470.00
54/3	125	19/26	340.00
54/4	250	19/26	430.00
54/5	500	24/29	450.00
54/6	1000	29/32	715.00
54/7	2000	34/35	1235.00

\* THERMOPLASTIC COATING CAN BE DONE AT EXTRA COST





**BOTTLES**

**55. BOTTLES REAGENT WIDE MOUTH WITH HOLLOW INTERCHANGEABLE STOPPER**

Cat No.	Cap.ml.	Joint	Price
55/1	30	24/29	490.00
55/2	60	24/29	510.00
55/3	125	29/32	540.00
55/4	250	34/35	690.00
55/5	500	40/38	990.00



55

**56. BOTTLES NARROW MOUTH SCREW CAP WITH RUBBER LINER AUTO CLAVABLE IDEAL FOR STORAGE UNDER COMPLETE SEAL**

Cat No.	Cap. ml.	Price
56/1	25	335.00
56/2	50	364.00
56/3	100	390.00
56/4	250	440.00
56/5	500	455.00
56/6	1000	650.00
56/7	2000	1200.00
56/8	5000	6600.00
56/9	10000	11900.00
56/10	20000	20300.00

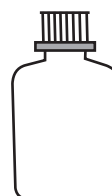

56

**57. BOTTLES ASPIRATOR WITH BOTTOM OUTLET FOR TUBING PLAIN**

Cat No.	Cap.ml.	Price
57/1	125	390.00
57/2	250	490.00
57/3	500	540.00
57/4	1000	840.00
57/5	2000	1450.00

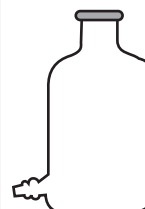

57

**58. BOTTLES ASPIRATOR WITH BOTTOM OUTLET FOR STOPPER**

Cat No.	Cap. ml.	Joint	Price
58/1	500	24/29	650.00
58/2	1000	29/32	1190.00
58/3	2000	34/35	1690.00



58

\* PTFE BOTTLES ALSO AVAILABLE





**BOTTLES**

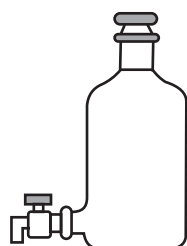

59

**59. BOTTLES ASPIRATOR WITH SCREWTHREAD OR INTER CHANGEABLE STOPPER AND STOPCOCK**

Cat No.	Cap. ml.	Neck Joint	Screw Thread	Bottom Joint	Price
59/1	1000	29/32	45	24/29	2900.00
59/2	2000	34/35	45	29/32	3450.00
59/3	5000	45/40	45	29/32	10450.00
59/4	10000	55/44	45	29/32	16500.00
59/5	20000	55/44	45	29/32	19500.00

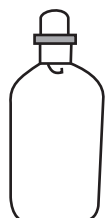

60

**60. BOTTLES BOD WITH INTERCHANGEABLE STOPPER**

Cat No.	Cap. ml.	Price
60/1	125	690.00
60/2	300	790.00

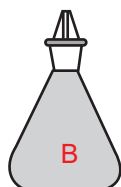

61

**61. BOTTLES SPECIFIC GRAVITY WITH INTERCHANGEABLE CAPILLARY P.T.E.F. STOPPER B CLASS**

Cat No.	Cap.ml	Joint	Price
61/1	5	10/15	490.00
61/2	10	10/15	690.00
61/3	25	10/15	690.00
61/4	50	10/15	740.00
61/5	100	10/15	790.00

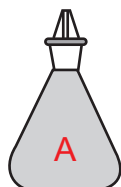

62

**62. BOTTLES SPECIFIC GRAVITY WITH INTERCHANGEABLE CAPILLARY P.T.F.E. STOPPER 'A' CLASS**

Cat No.	Cap. ml.	Joint	Price
62/1	5	10/15	1190.00
62/2	10	10/15	1290.00
62/3	25	10/15	1490.00
62/4	50	10/15	1590.00
62/5	100	10/15	1790.00





**BOTTLES**

**63. BOTTLES SPECIFIC GRAVITY WITH THERMOMETER**

Cat No.	Cap.ml.	Joint	Price
63/1	10	10/15	1590.00
63/2	25	10/15	3350.00
63/3	50	10/15	1890.00

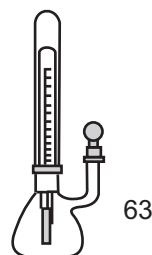

63

**64. BOTTLES WEIGHING WITH GROUND STOPPER INTERCHANGEABLE**

Cat No.	Dia x Ht.mm	Capml.	Price
64/1*	50 x 35	20	675.00
64/2*	60 x 40	40	942.00
64/3*	65 x 60	60	1290.00
64/4	20 x 40	5	340.00
64/5	25 x 60	15	390.00
64/6	30 x 65	25	490.00
64/7	40 x 90	60	690.00



64

\* SQUAT FORM

**65. TLC GLASS CHAMBER WITH LID** 760.00



65

**66. BOTTLES STOPPER WASH COMPLETE WITH I/C**

Cat No.	Cap. ml.	Joint	Price
66/1	250	24/29	840.00
66/2	500	24/29	1190.00
66/3	1000	24/32	1390.00
66/4	-	Spare Head for above	490.00
66/5	250	Spare Flask for above	590.00
66/6	500	Spare Flask for above	790.00
66/7	1000	Spare Flask for above	1190.00



66

\*





**BOTTLES**

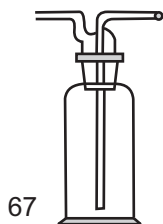

67

**67. BOTTLES GAS WASHING (DRECHSEL)**

Cat No.	Cap. ml.	Joint	Price
67/1	125	29/32	860.00
67/2	250	29/32	930.00
67/3	500	29/32	1340.00
67/4	1000	29/32	2300.00
67/5	125	Spare Bottles for above	750.00
67/6	250	Spare Bottles for above	750.00
67/7	500	Spare Bottles for above	900.00
67/8	1000	Spare Bottles for above	1600.00
67/9	-	Spare Head for above	690.00

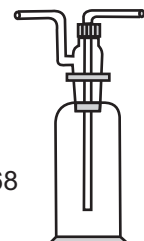

68

**68. BOTTLES GAS WASHING DRECHSEL WITH PTFE SCREW THREAD FOR EASY ADJUSTMENT OF DIPTUBES**

Cat No.	Cap. ml.	Joint	Price
68/1	125	29/32	830.00
68/2	250	29/32	1590.00
68/3	500	29/32	1890.00
68/4	1000	29/32	2990.00
68/5		Spare head for above	890.00

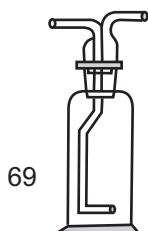

69

**69. BOTTLES GAS WASHING WITH SINTERED DISC FOR UNIFORM GAS DISPERSION UPWARD POROSITY G1-G4**

Cat No.	Cap. ml.	Joint	Price
69/1	125	40/38	1440.00
69/2	250	40/38	1540.00
69/3	500	40/38	1840.00
69/4		Spare Heads for above	790.00

PLEASE SPECIFY POROSITY G1-G4 WHILE PLACING ORDER

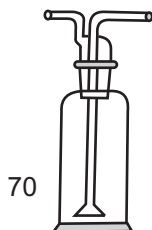

70

**70. BOTTLES GAS WASHING WITH SINTERED DISC FOR QUICK DISPERSION DOWNWARDS POROSITY G1-G4**

Cat No.	Cap. ml.	Joint	Price
70/1	125	29/32	1495.00
70/2	250	29/32	1540.00
70/3	500	29/32	1840.00
70/4		Spare Heads for above	790.00

\* PLEASE SPECIFY POROSITY G1-G4 WHILE PLACING ORDER





**BURETTES**

**71. BURETTES WITH STRAIGHT BORE STOPCOCK CLASS B.**

Cat No.	Cap. ml.	Sub-Div.	Tolerance	Price
71/1*	1	0.01	0.01	430.00
71/2*	2	0.02	0.02	430.00
71/3*	5	0.02	0.02	430.00
71/4	10	0.05	0.05	450.00
71/5	25	0.10	0.10	460.00
71/6	50	0.10	0.10	480.00
71/7	100	0.20	0.20	650.00

**72. BURETTES WITH STRAIGHT BORE STOPCOCK CLASS A WITH WORK CERTIFICATE**

Cat No.	Cap. ml.	Sub-Div.	Tolerance	Price
72/1*	1	0.01	0.006	1200.00
72/2*	2	0.02	0.01	1200.00
72/3*	5	0.02	0.01	1200.00
72/4	10	0.05	0.02	1230.00
72/5	25	0.10	0.05	1250.00
72/6	50	0.10	0.05	1350.00
72/7	100	0.20	0.10	1600.00

**73. BURETTES STRAIGHT PTFE SCREW COCK CLASS 'B'**

Cat No.	Cap. ml.	Sub-Div.	Tolerance	Price
73/1*	1	0.01	0.01	430.00
73/2*	2	0.02	0.02	430.00
73/3*	5	0.02	0.02	430.00
73/4	10	0.05	0.05	450.00
73/4	25	0.10	0.10	460.00
73/5	50	0.10	0.10	480.00
73/6	100	0.20	0.20	650.00

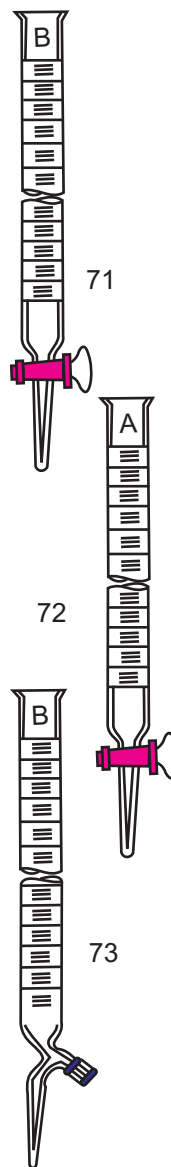





**BURETTES**

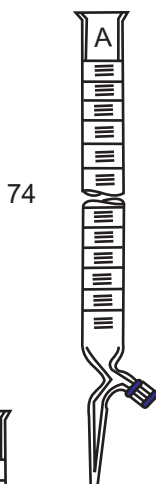

**74. BURETTES STRAIGHT BORE PTFE SCREW COCK CLASS A WITH WORK CERTIFICATE**

Cat No.	Cap. ml.	Sub-Div	Tolerance	Price
74/1*	1	0.01	0.006	2090.00
74/2*	2	0.02	0.01	2090.00
74/3*	5	0.02	0.01	2090.00
74/4	10	0.05	0.02	2090.00
74/5	25	0.10	0.05	2290.00
74/6	50	0.10	0.05	2690.00
74/7	100	0.20	0.10	3790.00

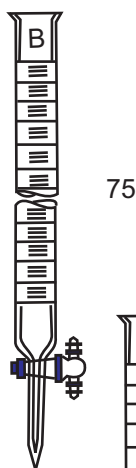

**75. BURETTES STRAIGHT BORE PTFE KEY STOPCOCK CLASS B**

Cat No.	Cap. ml.	Sub-Div.	Tolerance	Price
75/1*	1	0.01	0.01	1290.00
75/2*	2	0.02	0.02	1290.00
75/3*	5	0.02	0.02	1290.00
75/4	10	0.05	0.05	1290.00
75/5	25	0.10	0.10	1540.00
75/6	50	0.10	0.10	1640.00
75/7	100	0.20	0.20	1890.00

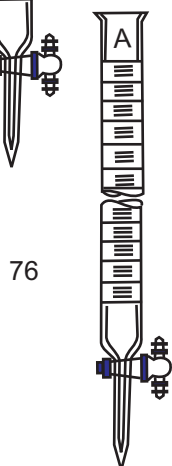

**76. BURETTES STRAIGHT BORE PTFE KEY STOPCOCK CLASS A WITH WORK CERTIFICATE**

Cat No.	Cap. ml.	Sub-Div.	Tolerance	Price
76/1*	1	0.01	0.006	2390.00
76/2*	2	0.02	0.01	2390.00
76/3*	5	0.02	0.01	2390.00
76/4	10	0.05	0.02	2390.00
76/5	25	0.10	0.05	2490.00
76/6	50	0.10	0.05	2610.00
76/7	100	0.20	0.10	3990.00

\* WITH CUP TOP





**BURETTES**

**77. BURETTE DOUBLE OBLIQUE BORE GLASS STOPCOCK CLASS B**

Cat No.	Cap. ml.	Sub-Div.	Tolerance	Price
77/1*	1	0.01	0.01	3790.00
77/2*	2	0.02	0.02	3790.00
77/3*	5	0.02	0.02	3790.00
77/4	10	0.05	0.05	2890.00
77/5	25	0.1	0.1	2890.00
77/6	50	0.1	0.1	2940.00
77/7	100	0.2	0.2	3290.00

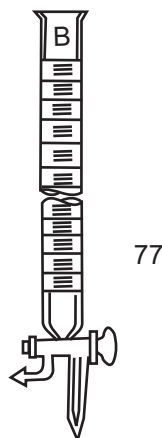

**78. BURETTE DOUBLE OBLIQUE BORE GLASS STOPCOCK CLASS A WITH WORK CERTIFICATE**

Cat No.	Cap. ml.	Sub-Div.	Tolerance	Price
78/1	1	0.01	0.006	4390.00
78/2	2	0.02	0.01	4390.00
78/3	5	0.02	0.01	4390.00
78/4	10	0.05	0.02	4790.00
78/5	25	0.10	0.05	4890.00
78/6	50	0.10	0.05	5290.00
78/7	100	0.20	0.10	6000.00

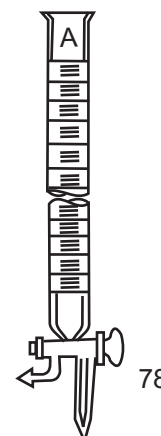

**79. BURETTE PRESSURE FILLING AUTOMATIC WITH RESERVOIR & GLASS STOPCOCK CLASS B**

Cat No.	Cap. ml.	Sub-Div.	Tolerance	Price
79/1	5	0.05	0.05	4390.00
79/2	10	0.05	0.05	4390.00
79/3	25	0.10	0.10	4650.00
79/4	50	0.10	0.10	5050.00
79/5	100	0.20	0.20	5850.00

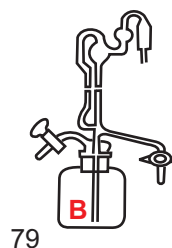



**BURETTES**

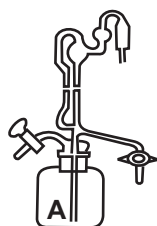

80

**80. BURETTE PRESSURE FILLING AUTOMATIC WITH RESERVOIR & GLASS STOPCOCK CLASS A WITH WORK CERTIFICATE**

Cat No.	Cap. ml.	Sub-Div	Tolerance	Price
80/1	5	0.05	0.02	6500.00
80/2	10	0.05	0.02	6500.00
80/3	25	0.10	0.05	6500.00
80/4	50	0.10	0.05	7000.00
80/5	100	0.20	0.10	7400.00

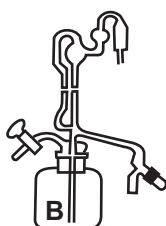

81

**81. BURETTE PRESSURE FILLING AUTOMATIC WITH RESERVOIR & PTFE SCREWCOCK CLASS B**

Cat No.	Cap. ml.	Sub-Div.	Tolerance	Price
81/1	5	0.05	0.05	4990.00
81/2	10	0.05	0.05	4490.00
81/3	25	0.10	0.10	5190.00
81/4	50	0.10	0.10	5590.00
81/5	100	0.20	0.20	6190.00

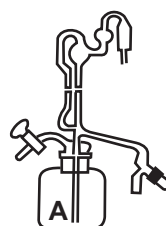

82

**82. BURETTE PRESSURE FILLING AUTOMATIC WITH RESERVOIR & GLASS STOPCOCK CLASS A WITH WORK CERTIFICATE**

Cat No.	Cap. ml.	Sub-Div	Tolerance	Price
82/1	5	0.05	0.02	8390.00
82/2	10	0.05	0.02	8390.00
82/3	25	0.10	0.05	8590.00
82/4	50	0.10	0.05	8990.00
82/5	100	0.20	0.10	8990.00





**CONDENSERS**

**83. CONDENSERS AIR PLAIN**

Cat No.	Length mm	Tube Dia mm	Price
83/1	300	13	195.00
83/2	450	13	210.00
83/3	600	13	240.00

**84. CONDENSERS LEIBIG PLAIN**

Cat No.	Length mm	Body Dia mm	Price
84/1	200	20	390.00
84/2	300	25	440.00
84/3	400	25	500.00
84/4	500	25	600.00
84/5	600	25	710.00

**85. CONDENSERS DAVIES (DOUBLE SURFACE)**

Cat No.	Jacket Length mm	Body Dia mm	Price
85/1	200	40	890.00
85/2	300	40	1190.00
85/3	450	40	1490.00

**86. CONDENSERS ALLIHN (BULB)**

Cat No.	Jacket Length mm	Body Dia mm	Price
86/1	200	35	495.00
86/2	300	35	790.00
86/3	400	35	940.00
86/4	500	35	1440.00

**87. CONDENSERS GRAHAM**

Cat No.	Jacket	Body Dia	Price
87/1	200	35	690.00
87/2	300	35	790.00
87/3	400	35	1090.00
87/4	500	35	1440.00

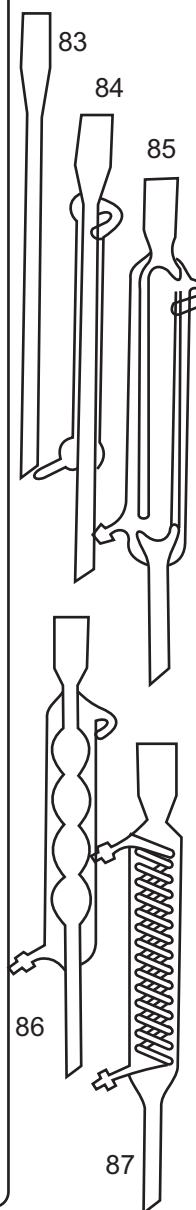



**CONDENSERS**

**88. CONDENSERS REFLUX HOPKIN**

Cat No.	Tube Dia mm	Length mm	Price
88/1	25	100	700.00
88/2	30	300	850.00
88/3	30	400	950.00

**89. CONDENSERS AIR WITH DRIP CONE**

Cat No.	Cone	Length mm	Price
89/1	14/23	400	290.00
89/2	19/26	400	340.00
89/3	24/29	500	390.00

**90. AIR CONDENSERS WITH CONE AND SOCKET FOR MATERIAL WITH BOILDING POINT ABOVE 150<sup>o</sup>c**

Cat No.	Joint	Length mm	Price
90/1	10/19	100	340.00
90/2	14/23	200	440.00
90/3	14/26	300	390.00
90/4	19/26	400	600.00
90/5	24/29	300	660.00
90/6	24/29	400	640.00
90/7	24/29	600	700.00
90/8	29/32	450	1190.00

**91. CONDENSERS LEIBIG**

Cat No.	Joint	Length mm	Price
91/1	10/19	60	390.00
91/2	10/19	150	440.00
91/3	14/23	150	440.00
91/4	14/26	200	490.00
91/5	19/26	300	600.00
91/6	19/26	450	790.00
91/7	19/26	600	1040.00
91/8	24/29	200	550.00
91/9	24/29	300	640.00
91/10	24/29	400	690.00
91/11	24/29	400	690.00
91/12	29/32	450	850.00
91/13	29/32	600	1100.00
91/14	34/35	450	1300.00
91/15	34/35	600	1400.00

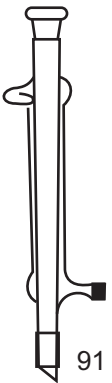
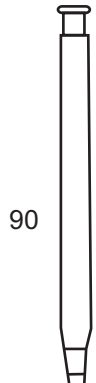
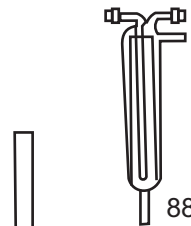



**CONDENSERS**

**92. CONDENSERS LEIBIG WITH CONE**

Cat No.	Cone	Effective Length mm	Price
92/1	19/26	300	390.00
92/2	19/26	400	740.00
92/3	19/26	500	840.00
92/4	24/29	400	690.00
92/5	24/29	500	890.00

**93. CONDENSERS COLD FINGER IMERSION**

Cat No.	Cone size	Effective Length mm	Price
93/1	19/26	100	590.00

**94. CONDENSERS DOUBLE SURFACE DAVIES**

Cat No.	Cone	Effective Length mm	Price
94/1	24/29	200	1090.00
94/2	29/32	200	1290.00
94/3	34/35	200	1290.00
94/4	40/38	300	1590.00
94/5	50/42	300	1990.00

**95. CONDENSERS DOUBLE SURFACE DAVIES**

C No.	Joints	Effective Length mm	Price
95/1	10/19	100	590.00
95/2	14/23	150	690.00
95/3	19/26	200	1090.00
95/4	19/26	300	1200.00
95/5	19/26	400	1530.00
95/6	24/29	200	1110.00
95/7	24/29	300	1310.00
95/8	24/29	400	1600.00
95/9	29/32	300	2290.00
95/10	29/32	400	2590.00
95/11	34/35	400	3090.00
95/12	34/35	600	3590.00

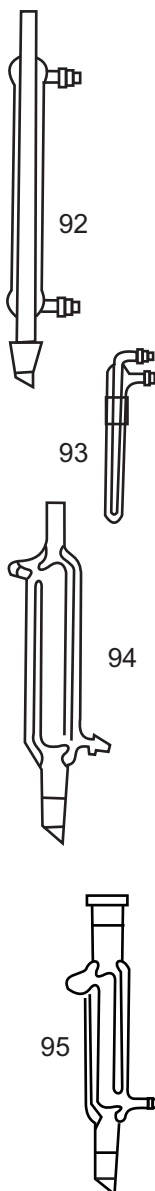



**CONDENSERS**

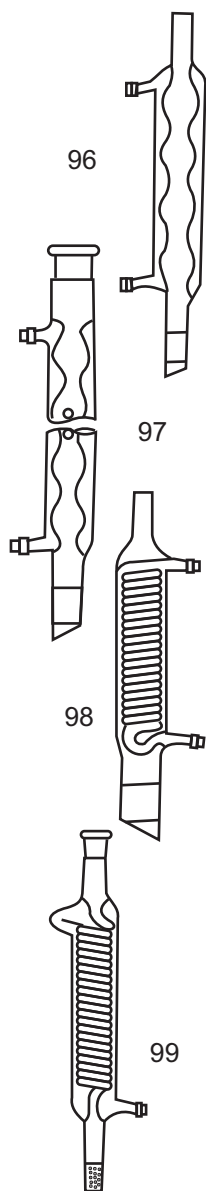

**96. CONDENSERS BULB ALLIHN**

Cat No.	Cone	Effective Length mm	Price
96/1	19/26	150	650.00
96/2	19/26	200	690.00
96/3	24/29	200	780.00
96/4	29/32	200	990.00
96/5	34/35	200	1040.00
96/6	40/38	200	1240.00
96/7	45/40	300	1490.00
96/8	50/42	300	2090.00

**97. CONDENSERS BULB ALLIHN**

Cat No.	Joints	Effective Length mm	Price
97/1	14/23	150	690.00
97/2	19/26	200	890.00
97/3	24/29	300	1090.00
97/4	24/29	400	1190.00
97/5	29/32	600	2190.00

**98. CONDENSERS GRAHAM COIL**

Cat No.	Cone	Effective Length mm	Price
98/1	34/35	200	890.00
98/2	40/38	200	940.00
98/3	45/40	200	1040.00
98/4	50/42	200	1190.00

**99. CONDENSERS GRAHAM COIL**

Cat No.	Joints	Effective Length mm	Price
99/1	19/26	150	700.00
99/2	19/26	300	810.00
99/3	24/29	300	840.00
99/4	24/29	400	950.00
99/5	24/29	500	1050.00
99/6	29/32	300	1300.00
99/7	29/32	450	1400.00
99/8	34/35	300	1500.00
99/9	34/35	450	1600.00





**CONDENSERS**

**100. JACKETED COIL CONDENSERS**

Cat No.	Joints	Effective Length mm	Price
100/1	19/26	150	990.00
100/2	19/26	250	1100.00
100/3	24/29	150	1200.00
100/4	24/29	250	1300.00
100/5	29/32	150	1350.00
100/6	29/32	300	1400.00
100/7	34/35	300	1800.00

**101. CONDENSERS DOUBLE COIL**

Cat No.	Joints	Effective Length mm	Price
101/1	19/26	200	3800.00
101/2	24/29	200	4700.00
101/3	29/32	250	5000.00
101/4	29/32	450	5300.00
101/5	34/35	250	6000.00
101/6	34/35	450	6700.00

**102 CONDENSERS TRIPLE COIL WITH COMMON INLET**

Cat No.	Joints	Length mm	Price
102/1	34/35	450	8990.00
102/2	45/40	450	15990.00

**103. CONDENSERS INLAND REVENUE (THROPE)**

Cat No.	Joints	Effective Length mm	Price
103/1	19/26	200	2950.00
103/2	24/29	200	3100.00

**104. CONDENSER ETHER**

Cat No.	Cone	Socket	Length mm	Price
104/1	24/29	19/26	180	5590.00

**105. CONDENSER FRIEDRICHS**

Cat No.	Joints	Effective length mm	Price
105/1	19/26	100	3190.00

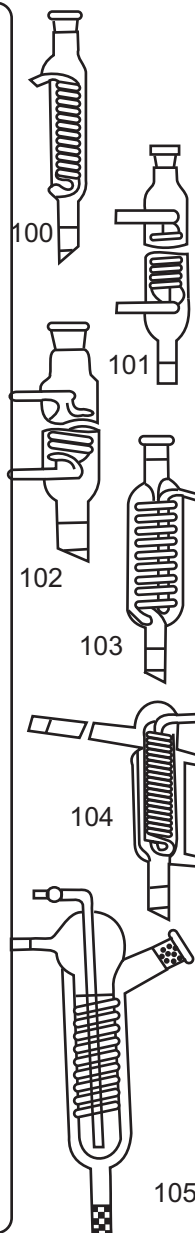





**CONDENSERS**

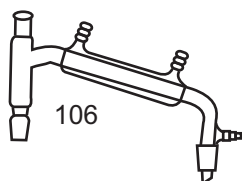

**106. DISTILLATION CONDENSER D.S. WITH STILL HEAD AND VACUUM BEND**

Cat No.	Joint	Price Plain	Price Vigreux
106/1	14/23	2500.00	5390.00
106/2	19/26	2950.00	6290.00
106/3	24/29	3500.00	7390.00
106/4	29/32	3950.00	8290.00

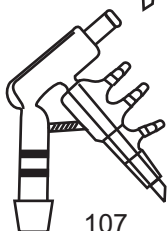

**107. SHORT PARTH CONDENSER**

Cat No.	Joint	Price
107/1	14/23	4790.00
107/2	19/26	5390.00
107/3	24/29	5590.00
107/4	29/32	6390.00

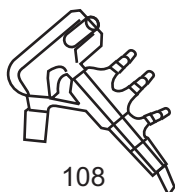

**108. DISTILLING HEAD, MICRO SHORT PATH, JACKETED**

Cat No.	Joint	Thermometer Seal Joint	Length mm	Price
108/1	B 14/23	14/23	110mm	6990.00
108/2	B 19/26	14/23	110mm	7390.00
108/3	B 14/23	14/23	150mm	7790.00
108/4	B 19/26	14/23	150mm	7990.00

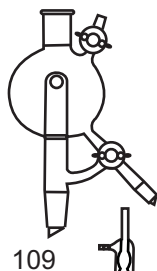

**109. DISTILLING HEAD, SOLVENT PURIFICATION COMPONENT OF APPARATUS USED TO PREPARE DRY, DEOXYGENATED SOLVENTS. FLASK PROVIDES STORAGE AND ACCESS BY SYRINGE. DRAINAGE OR RETURN TO THE BOILING FLASK IS ACCOMPLISHED WITH A T-BORE PTFE STOPCOCK**

Cat No.	Flask size mm	Joint	Price
109/1	250	14/12	6390.00
109/2	500	24/24	8390.00
109/3	1000	24/24	9590.00
109/4	2000	34/35	10590.00
109/5	5000	34/35	13590.00

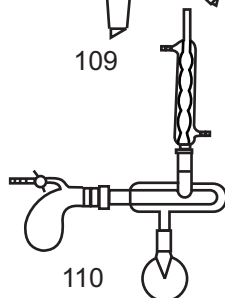

**110. DRYING APPARATUS VACUUM,**

Cat No.	Height & Width	Price
110/1	740 x 350	31990.00





**COLUMNS**

**111. COLUMNS CHROMATOGRAPHY WITH GLASS STOPCOCK**

Cat No.	Bore mm	Length mm	Price
111/1	11	300	450.00
111/2	11	500	550.00
111/3	19	300	650.00
111/4	19	500	660.00
111/5	28	450	680.00
111/6	28	600	900.00

**112. COLUMN CHROMATOGRAPHY WITH PTFE SCREW COCK**

Cat No.	Bore mm	Length mm	PTFE Plug	Price
112/1	11	300	590.00	510.00
112/2	11	500	640.00	630.00
112/3	19	300	675.00	710.00
112/4	19	500	775.00	910.00
112/5	28	450	925.00	1230.00
112/6	28	600	1000.00	1290.00

**113. COLUMNS CHROMATOGRAPHY WITH SINTERED DISC POROSITY G1-G4**

Cat No.	Bore mm	Length mm	Price
113/1	11	300	240.00
113/2	11	500	390.00
113/3	19	300	530.00
113/4	19	500	690.00
113/5	28	450	1090.00
113/6	28	600	1290.00

**114. COLUMNS CHROMATOGRAPHY WITH SINTERED DISC AND GLASS STOPCOCK G1-G4**

Cat No.	Bore mm	Length mm	PTFE Plug	Price
114/1	11	300	750.00	690.00
114/2	11	500	900.00	750.00
114/3	19	300	900.00	830.00
114/4	19	500	965.00	850.00
114/5	28	450	1150.00	960.00
114/6	28	600	1250.00	1200.00

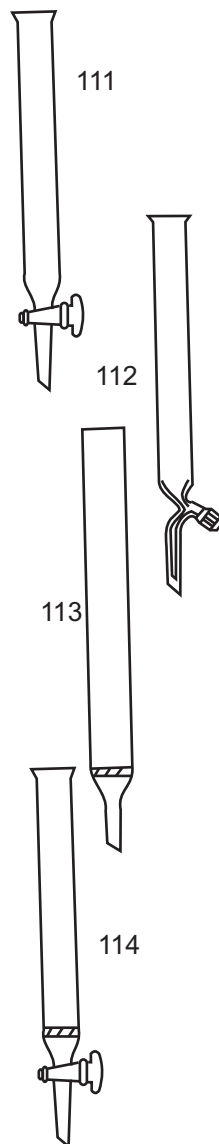



**CONDENSERS**

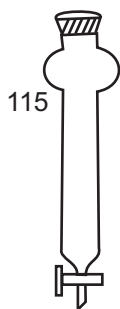

**115. GLASS COLUMN WITH RESERVOIR AND STOPCOCK**

Cat No.	Dia mm	Length mm	Price	
			glass stopcock	PTFE Stopcock
115/1	30	400	1800.00	3600.00
115/2	40	450	2100.00	4360.00
115/3	50	500	2400.00	4640.00
115/4	60	600	3500.00	5500.00

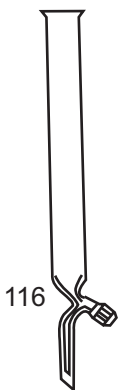

**116. COLUMNS CHROMATOGRAPHY WITH SINTERED DISC PTFE SCREW COCK**

Cat No.	Bore mm	Length mm	Price
116/1	11	300	690.00
116/2	11	500	820.00
116/3	19	300	1010.00
116/4	19	500	1210.00
116/5	28	450	1640.00
116/6	28	600	1870.00

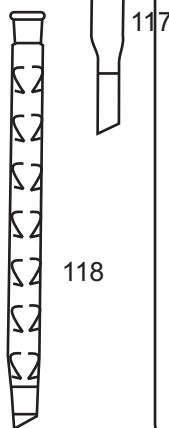

**117. COLUMNS FRACTIONATING PLAIN**

Cat No.	Socket	Cone	Length mm	Price
117/1	24/29	24/29	250	590.00
117/2	24/29	24/29	500	640.00
117/3	24/29	24/29	750	720.00
117/4	29/32	29/32	500	900.00
117/5	34/35	34/35	500	1200.00

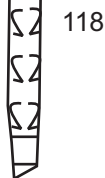

**118. COLUMNS FRACTIONATING VIGREUX**

Cat No.	Socket	Cone	Length mm	Price
118/1	24/29	24/29	400	880.00
118/2	24/29	24/29	600	1070.00
118/3	29/32	29/32	400	1400.00
118/4	34/35	34/35	450	1900.00
118/5	34/35	34/35	600	2700.00

30





**CONDENSERS**

**119. COLUMNS DUFTON**

Cat No.	Socket	Cone	Length mm	Price
119/1	19/26	19/26	150	1490.00
119/2	19/26	19/26	300	1790.00
119/3	24/29	19/26	300	2090.00

**120. COLUMNS VIGREUX WITH JACKET**

Cat No.	Socket	Cone	Length mm	Price
120/1	24/29	19/26	360	5890.00

**121. COLUMNS CHROMATOGRAPHY WITH SINTERED DISC POROSITY G1-G4**

Cat No.	Bore mm	Length mm	Socket size	Cone size	Price
121/1	10	200	14/23	19/26	650.00
121/2	10	300	14/23	19/26	690.00
121/3	10	400	14/23	19/26	790.00
121/4	18	200	24/29	19/26	890.00
121/5	18	300	24/29	19/26	970.00
121/6	18	400	24/29	19/26	1030.00
121/7	30	200	34/35	24/29	1530.00
121/8	30	300	34/35	24/29	1630.00
121/9	30	400	34/35	24/29	1650.00

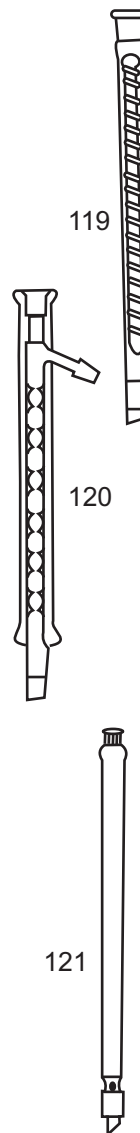



**CONDENSERS**

**122. COLUMNS CHROMATOGRAPHY WITH SINTERED DISC AND STOPCOCK POROSITY G1-G4**

Cat No.	Bore mm	Length mm	Socket size	Cone Size Stopcock	Plain PTFE Plug	Price
122/1	10	100	14/23	19/26	850.00	1130.00
122/2	10	200	14/23	19/26	900.00	1190.00
122/3	10	300	14/23	19/26	850.00	1310.00
122/4	18	100	24/29	19/26	1050.00	1390.00
122/5	18	200	24/29	19/26	1100.00	1440.00
122/6	18	300	24/29	19/26	1200.00	1590.00
122/7	30	200	34/35	24/29	1800.00	2690.00
122/8	30	300	34/35	24/29	1900.00	2790.00
122/9	30	400	34/35	24/29	1950.00	2890.00

**123. TAMPING RODS FOR USE IN COLUMNS**

Cat No.	Length mm	Dia mm	Price
123/1	400	7	330.00
123/2	600	7	380.00

PLEASE SPECIFY POROSITY OF SINTERED DISC G1-G4

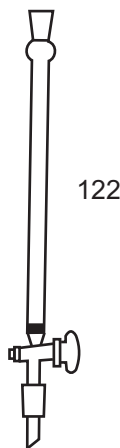

32





**MEASURING CYLINDERS**

**124. CYLINDERS MEASURING STOPPERED CLASS 'B'**

Cat No.	Cap. ml	Stopper size	Sub-Div.	Tolerance	Price
124/1	5	10/15	0.1	0.1	490.00
124/2	10	10/15	0.2	0.2	550.00
124/3	25	14/15	0.5	0.5	570.00
124/4	50	14/15	1.0	1.0	620.00
124/5	100	19/20	1.0	1.0	790.00
124/6	250	24/25	2.0	2.0	1290.00
124/7	500	24/25	5.0	5.0	1850.00
124/8	1000	34/25	10.0	10.0	2600.00
124/9	2000	34/25	20.0	20.0	4500.00

**125. CYLINDERS MEASURING STOPPERED CLASS 'A' WITH WORK CERTIFICATE**

Cat No.	Cap ml.	Stopper size	Sub-Div.	Tolerance	Price
125/1	5	10/15	0.1	0.05	940.00
125/2	10	10/15	0.2	0.10	1090.00
125/3	25	14/15	0.5	0.25	1190.00
125/4	50	14/15	1.0	0.50	1390.00
125/5	100	19/20	1.0	0.50	1490.00
125/6	250	24/25	2.0	1.00	2380.00
125/7	500	24/25	5.0	2.50	2950.00
125/8	1000	34/25	10.0	5.00	3650.00
125/9	2000	34/25	20.0	10.00	5900.00

**126. CYLINDERS MEASURING WITH SPOUT CLASS 'B'**

Cat No.	Cap. ml.	Sub-Div.	Tolerance	Price
126/1	5	0.1	0.1	290.00
126/2	10	0.2	0.2	370.00
126/3	25	0.5	0.5	400.00
126/4	50	1.0	1.0	440.00
126/5	100	1.0	1.0	490.00
126/6	250	2.0	2.0	930.00
126/7	500	5.0	5.0	1240.00
126/8	1000	10.0	10.0	1820.00
126/9	2000	20.0	20.0	3610.00

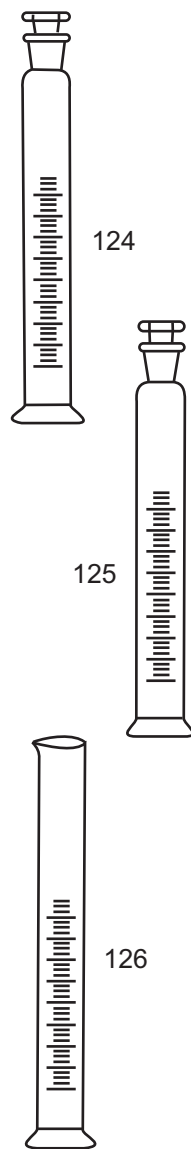



**MEASURING CYLINDERS**

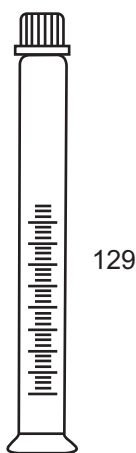
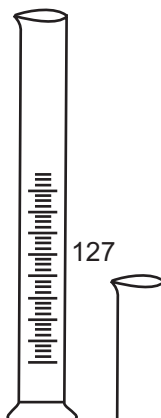

**127. CYLINDERS MEASURING WITH SPOUT CLASS 'A' WITH WORK CERTIFICATE**

Cat No.	Cap.ml.	Sub-Div. ml.	Tolerance ml.	Price
127/1	5	0.1	0.05	590.00
127/2	10	0.2	0.10	640.00
127/3	25	0.5	0.25	690.00
127/4	50	1.0	0.50	890.00
127/5	100	1.0	0.50	950.00
127/6	250	2.0	1.00	1430.00
127/7	500	5.0	2.50	1940.00
127/8	1000	10.0	5.00	2590.00
127/9	2000	20.0	10.00	4990.00

**128. CYLINDER COLOUR COMPARISON NESSLER WITH CLEAR FLAT BOTTOM**

Cat No.	Cap. ml	Sub.Div. ml.	Price
128/1	50	25-50	230.00
128/2	100	50-100	340.00

**129. CYLINDER MEASURING WITH SCREW CAP CLASS 'B'**

Cat No.	Cap. ml.	Sub-Div. ml.	Tolerance ml.	Price
129/1	10	0.2	0.2	510.00
129/2	25	0.5	0.5	530.00
129/3	50	1.0	1.0	640.00
129/4	100	1.0	1.0	690.00
129/5	250	2.0	2.0	1190.00





**MEASURING CYLINDERS**

**130. CROW RECEIVERS CLASS 'B' WITH SPOUT WIDE BASE FOR EXTRA STABILITY**

Cat No.	Cap. ml.	Price
130/1	25	550.00
130/2	50	650.00
130/3	100	730.00

**131. CROW RECEIVERS CLASS 'A' WITH SPOUT WITH WORK CERTIFICATE WIDE BASE FOR EXTRA STABILITY**

Cat No.	Cap. ml	Price
131/1	25	1590.00
131/2	50	2090.00
131/3	100	2490.00

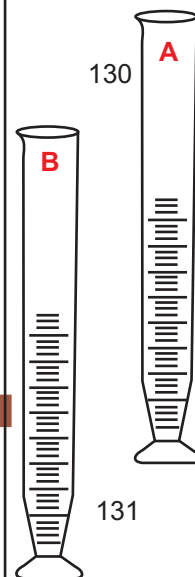

**PETRIDISC**

**132. DISHES CULTURE PETRI UNLIMITED AUTOCLAVABLE (Petridisc)**

Cat No.	OD x Ht.mm	Price
132/1	50 X 17	220.00
132/2	80 X 17	250.00
132/3	110 X 17	300.00
132/4	150 X 20	750.00
132/5	200 X 20	1650.00

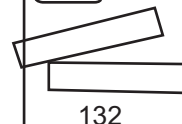

**129. DISH EVAPORATING WITHOUT SPOUT**

Cat No.	OD x Ht mm	Price
133/1	80 x 45	490.00
133/2	100 x 55	600.00
133/3	150 x 80	1090.00
133/4	200 x 100	2050.00

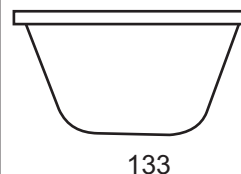

**134. DISH CRYSTALLIZING**

Cat No.	OD x Ht mm	Price
134/1	100 x 50	530.00
134/2	150 x 75	840.00
134/3	190 x 100	1420.00

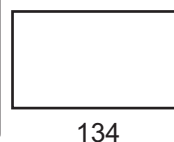





**GLASS HEATING COIL ROUND**

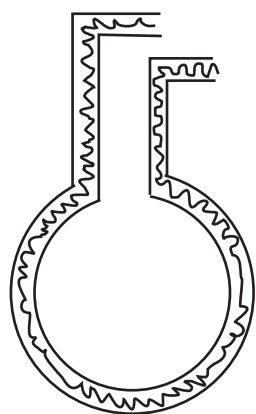

135

**135. GLASS HEATING COIL ROUND**

Cat No.	Size	Price
135/1	4"	1090.00
135/2	6"	1290.00
135/3	8"	1490.00





**FLASKS**

**136 FLASK ROUND / FLAT WITH INTERCHANGEABLE JOINT SHORT NECK**

Cat No.	Cap. ml.	Socket	Price
136/1	10	14/23	195.00
136/2	25	14/23	190.00
136/3	25	19/26	190.00
136/4	50	14/23	190.00
136/5	50	19/26	190.00
136/6	50	24/29	190.00
136/7	50	29/32	200.00
136/8	50	34/35	230.00
136/9	100	14/23	200.00
136/10	100	19/26	200.00
136/11	100	24/29	200.00
136/12	100	29/32	260.00
136/13	100	34/35	300.00
136/14	150	19/26	240.00
136/15	150	24/29	240.00
136/16	150	29/32	320.00
136/17	150	34/35	340.00
136/18	250	14/23	250.00
136/19	250	19/26	250.00
136/20	250	24/29	250.00
136/21	250	29/32	290.00
136/22	250	34/35	300.00
136/23	500	19/26	360.00
136/24	500	24/29	360.00
136/25	500	29/32	380.00
136/26	500	34/35	440.00
136/27	1000	19/26	500.00
136/28	1000	24/29	500.00
136/29	1000	29/32	520.00
136/30	1000	34/35	530.00
136/31	2000	24/29	920.00
136/32	2000	29/32	920.00
136/33	2000	34/35	940.00
136/34	3000	24/29	2610.00
136/35	3000	29/32	2610.00
136/36	3000	34/35	2650.00
136/37	3000	55/44	2700.00
136/38	5000	24/29	3800.00
136/39	5000	29/32	3800.00
136/40	5000	34/35	3800.00
136/41	5000	55/44	3850.00
136/42	10000	34/35	7200.00
136/43	10000	45/50	7200.00
136/44	10000	55/44	7200.00
136/45	20000	34/35	12500.00
136/46	20000	45/50	12500.00
136/47	20000	55/44	12500.00
136/48	20000	60/46	12500.00

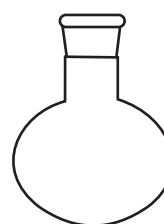

136





**FLASKS**

**137. FLASK ROUND BOTTOM 2 NECK WITH INTERCHANGEABLE JOINT SIDE NECK ANGLED OR PARALLEL**



137



Cat No.	Cap. ml.	Centre Socket	Side Socket	Price
137/1	10	14/23	10/15	210.00
137/2	25	14/23	10/15	220.00
137/3	25	19/23	14/23	260.00
137/4	50	19/23	14/23	260.00
137/5	50	24/25	19/23	270.00
137/6	100	24/29	14/23	330.00
137/7	100	24/29	19/26	330.00
137/8	250	24/29	14/23	390.00
137/9	250	24/29	19/26	390.00
137/10	500	24/29	14/23	530.00
137/11	500	24/29	19/26	530.00
137/12	1000	24/29	14/23	650.00
137/13	1000	24/29	19/26	650.00
137/14	1000	29/32	19/26	650.00
137/15	2000	24/29	19/26	1150.00
137/16	2000	34/35	19/26	1150.00
137/17	2000	34/35	19/26	1150.00
137/18	3000	24/29	19/26	3000.00
137/19	3000	34/35	19/26	3000.00
137/20	3000	34/35	24/29	3000.00
137/21	5000	34/35	19/26	4450.00
137/22	5000	34/35	24/29	4450.00
137/23	5000	34/35	29/32	4450.00
137/24	5900	55/44	34/25	4450.00
137/25	10000	34/35	24/29	8200.00
137/26	10000	34/35	29/32	8200.00
137/27	10000	55/44	34/35	8200.00
137/28	20000	34/35	24/29	13500.00
137/29	20000	55/44	34/35	13500.00

\* SIDE SOCKET CAN BE CHANGE AS PER YOUR REQUIREMENT  
 \* PLEASE MENTION SIDE NECK ANGLE OR PARALLEL





**FLASKS**

**138. FLASK ROUND BOTTOM 3 NECK WITH INTERCHANGEABLE JOINT SIDE NECK ANGLED OR PARALLEL**

Cat No.	Cap. ml.	Centre Socket	Side Socket	Price
138/1	25	19/26	14/23	330.00
138/2	50	19/26	14/23	340.00
138/3	100	19/26	14/23	400.00
138/4	100	24/29	14/23	400.00
138/5	250	19/26	14/23	490.00
138/6	250	24/29	19/26	490.00
138/8	500	19/26	14/23	700.00
138/8	500	24/29	14/23	700.00
138/9	500	24/29	19/26	700.00
138/10	500	19/32	19/26	720.00
138/11	1000	24/29	19/26	720.00
138/12	1000	29/32	19/26	830.00
138/13	1000	34/35	24/29	830.00
138/14	2000	24/29	19/26	1515.00
138/15	2000	29/32	19/26	1515.00
138/16	2000	34/34	29/29	1515.00
138/17	3000	24/29	19/26	3400.00
138/18	3000	29/32	19/26	3400.00
138/19	3000	34/35	24/29	3400.00
138/20	3000	45/40	24/29	3400.00
138/21	5000	24/29	19/26	4900.00
138/22	5000	34/35	24/29	4900.00
138/23	5000	45/40	24/29	4900.00
138/24	10000	34/35	24/29	9900.00
138/25	10000	55/44	24/29	9900.00
138/26	10000	55/44	34/35	9900.00
138/27	20000	34/35	24/29	18000.00
138/28	20000	55/44	34/35	18000.00

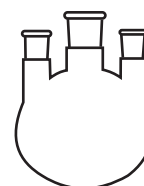

138



**139. FLAT THREE NECK WITH P.T.F.E. STOPCOCK**

Cat No.	Cap. ml	Centre Joint	Side	Price
139/1	100	24/29	19/26	1800.00
139/2	250	24/29	19/26	1840.00
139/3	500	24/29	19/26	2090.00
139/4	500	24/29	24/29	2090.00
139/5	1000	24/29	24/29	2360.00
139/6	1000	29/32	24/29	2360.00
139/7	2000	29/32	24/29	3210.00

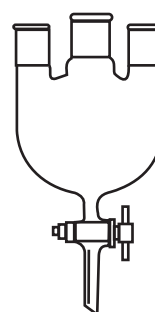

139





**FLASKS**

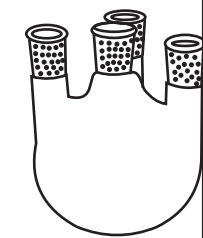

140

**140. FLASK ROUND BOTTOM 4 NECK WITH INTERCHANGE ABLE JOITN SIDE NECK ANGLE OR PARALLEL**

Cat No.	Cap. ml.	Centre Socket	Side Socket	Price
140/1	25	Any Size	Any Size	421.00
140/2	50	Any Size	Any Size	490.00
140/3	100	Any Size	Any Size	590.00
140/4	250	Any Size	Any Size	700.00
140/5	500	Any Size	Any Size	990.00
140/6	1000	Any Size	Any Size	1230.00
140/7	2000	Any Size	Any Size	1900.00
140/8	3000	Any Size	Any Size	4750.00
140/9	5000	Any Size	Any Size	6550.00
140/10	10000	Any Size	Any Size	11700.00
140/11	20000	Any Size	Any Size	18500.00

\* SOCKET CAN BE CHANGED AS PER YOUR REQUIREMENT.  
\* PLEASE MENTION SIDE NECK ANGLE OR PARALLEL

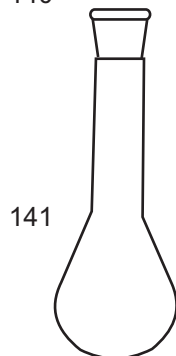

141

**141. FLASK KJELDAHL**

Cat No.	Cap. ml.	Socket	Price
141/1	100	24/29	390.00
141/2	300	24/29	451.00
141/3	500	24/29	1040.00
141/4	800	24/29	1190.00

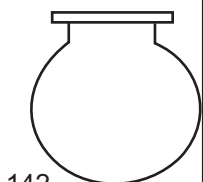

142

**142. FLASK FLAT FLANGE REACTION**

Cat No.	Cap. ml.	Flange Bore mm	Price
142/1	1000	100	2590.00
142/2	2000	100	3390.00
142/3	3000	100	3390.00
142/4	5000	100	6990.00
142/5	10000	100	11190.00
142/6	20000	100	25190.00



143

**143. MULTI SOCKET FLAT FLANGE LIDS 100MM BORE**

Cat No.	Centre Joint	Side Joint	Price
143/1	19/26 to 34/35	1 x 24/29A 1 x 19/26P	4490.00





**REACTION VESSELS & LIDS**

**144. REACTION VESSEL, CYLINDRICAL WITH FLAT FLANGE**

Cat No.	Cap. ml.	Price
144/1	250	4990.00
144/2	500	4990.00
144/3	1000	7990.00
144/4	2000	10990.00
144/5	4000	14990.00

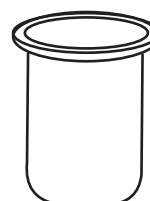

144

**145. REACTION VESSEL, LID SINGLE NECK FLAT FLANGE**

Cat No.	Cap. ml.	Price
145/1	250	5590.00
145/2	500	7590.00
145/3	1000	7590.00
145/4	2000	10590.00
145/5	4000	10590.00

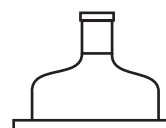

145

**146. REACTION VESSEL, LID THREE NECK FLAT FLANGE**

Cat No.	Cap. ml.	Price
146/1	250	6590.00
146/2	500	8590.00
146/3	1000	8590.00
146/4	2000	11590.00
146/5	4000	11590.00

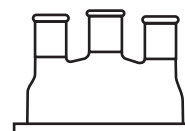

146

**147. REACTION VESSEL, LID FOUR NECK FLAT FLANGE**

Cat No.	Cap. ml.	Price
147/1	250	7990.00
147/2	500	9990.00
147/3	1000	9990.00
147/4	2000	12990.00
147/5	4000	12990.00

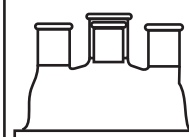

147





**REACTION VESSELS & LIDS**

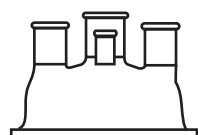

148

**148. REACTION VESSEL, LID 5 NECK FLAT FLANGE**

Cat No.	Cap. ml.	Price
148/1	500	10590.00
148/2	1000	10590.00
148/3	2000	13590.00
148/4	4000	13590.00

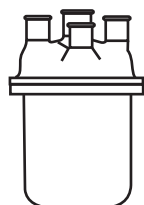

149

**149. KETLES RESIN REACTION WITH LID,**

Cat No.	Cap. ml.	Price
149/1	100	5500.00
149/2	250	7300.00
149/3	500	8500.00
149/4	1000	9600.00
149/5	2000	10500.00
149/6	4000	15300.00



150

**150. REACTION VESSEL COMBO WITH LID, CLIP, Baffle, STIRRER, STOPPER & STIRRER GUIDE**

Cat No.	Cap. ml.	Price
150/1	100	11990.00
150/2	250	11990.00
150/3	500	15990.00
150/4	1000	17990.00



151

**151. REACTION VESSEL, CYLINDRICAL JACKETED**

Cat No.	Cap. ml.	Price
151/1	250	xx
151/2	500	xx
151/3	1000	xx
151/4	2000	xx

xx Price on Request.





**FLANGES/CLIPS & FLASKS**

**152. FLAT FLANGE JOINT CLIP AND GASKET**

Cat No.	Flange Size	Price
152/1	100mm	380.00

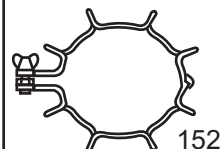

**153. SHLENK FLASKS**

Cat No.	Cap. ml	Socket	Price
153/1	50	B-19	690.00
153/2	100	B-24	690.00
153/3	250	B-24	840.00
153/4	500	B-24	990.00



**154. ROTAVAP FLASK**

Cat No.	Size	Joint	Price
154/1	50	19/26	690.00
154/2	100	29/32	840.00
154/3	250	29/32	1290.00
154/4	500	29/32	1490.00
154/5	800	29/32	1190.00
154/6	1000	29/32	2590.00
154/7	2000	29/32	3390.00

153

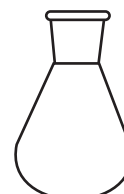

154

**155. FLASK FILTERING BUCHNER THICK WALL FOR FILTRATION UNDER VACUUM**

Cat No.	Cap. ml.	Socket	Price
155/1	50	14/23	350.00
155/2	100	19/26	550.00
155/3	100	24/29	740.00
155/4	250	24/29	940.00
155/5	250	29/32	940.00
155/6	500	24/29	940.00
155/7	500	29/32	940.00
155/8	1000	24/29	1390.00
155/9	1000	29/32	1390.00
155/10	2000	24/29	2200.00
155/11	2000	29/32	2200.00
155/12	5000	24/29	7500.00
155/13	5000	34/35	7500.00
155/14*	10000	55/44	13000.00
155/15*	20000	55/44	18500.00



155

\* Bottle Shaped







**FLASKS RECEIVING**

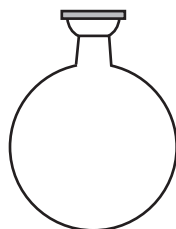

156

**156. FLASK RECEIVING SPHERICAL JOINT,**

Cat No.	Cap. ml.	Joint	Price
156/1	500	35/20	1490.00
156/2	1000	35/20	2590.00
156/3	2000	35/20	2990.00
156/4	3000	35/20	3590.00

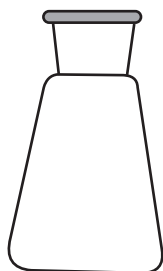

157

**157. FLASK CONICAL WITH INTERCHANGEABLE JOINT**

Cat No.	Cap. ml.	Socket	Price
157/1	5-10	10/19	150.00
157/2	5-10	14/23	150.00
157/3	25	10/19	170.00
157/4	25	14/23	170.00
157/5	25	19/26	170.00
157/6	50	14/23	200.00
157/7	50	19/26	200.00
157/8	50	24/29	200.00
157/9	100	14/23	220.00
157/10	100	19/26	220.00
157/11	100	24/29	240.00
157/12	100	29/32	265.00
157/13	150	19/26	265.00
157/14	150	24/29	265.00
157/15	150	29/32	265.00
157/16	250	19/26	270.00
157/17	250	24/29	270.00
157/18	250	29/32	280.00
157/19	250	34/35	290.00
157/20	500	19/26	430.00
157/21	500	24/29	430.00
157/22	500	29/32	470.00
157/23	500	34/35	480.00
157/24	1000	24/29	710.00
157/25	1000	29/32	710.00
157/26	1000	29/32	710.00
157/27	2000	24/29	1290.00
157/28	2000	29/32	1290.00
157/29	2000	34/35	1290.00





**158. FLASK IODINE WITH INTERCHANGEABLE STOPPER CUP SHAPED OR FUNNEL SHAPED**

Cat No.	Cap. ml.	Socket	Price
158/1	100	24/20	250.00
158/2	250	24/29	320.00
158/3	500	24/29	410.00
158/4	1000	24/29	840.00

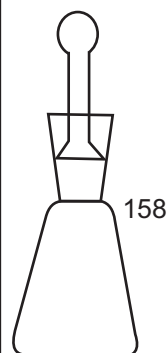

**159. FLASK CONICAL WITH INTERCHANGEABLE STOPPER**

Cat No.	Cap. ml.	Socket	Price
159/1	10	10/19	210.00
159/2	25	14/23	230.00
159/3	50	19/26	250.00
159/4	100	19/26	310.00
159/5	150	19/26	350.00
159/6	250	24/29	440.00
159/7	500	24/29	590.00
159/8	1000	24/29	890.00

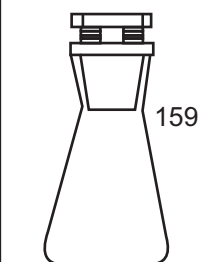

**160. FLASK PEAR SHAPED SINGLE**

Cat No.	Cap.ml	Socket	Price
160/1	5-10	10/19	160.00
160/2	5-10	14/23	160.00
160/3	25	10/19	200.00
160/4	25	14/23	200.00
160/5	50	14/23	280.00
160/6	50	19/26	280.00
160/7	100	14/23	421.00
160/8	100	19/26	421.00
160/9	100	24/29	410.00
160/10	250	24/29	940.00
160/11	250	29/32	940.00
160/12	500	29/32	1370.00

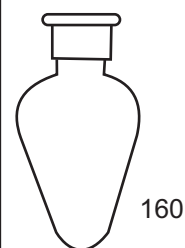



161

### 161. FLASK PEAR SHAPED 2 NECK SIDE ANGLE NECK

Cat No.	Cap.	Centre	Side	Price
161/1	25	14/23	14/23	340.00
161/2	50	14/23	14/23	490.00
161/3	100	14/23	14/23	570.00

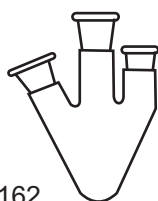

162

### 162. FLASK PEAR SHAPED 3 NECK ONE SIDE PARALLEL ONE ANGLED NECK,

Cat No.	Cap. mt.	Centre socket	Side socket	Price
162/1	25	14/23	14/23	490.00
162/2	50	14/23	14/23	590.00
162/3	100	14/23	14/23	740.00



163

### 163. FLASK SULHPONATION 4 NECK

Cat No.	Cap. ml.	Centre Socket	Side Socket	Price
163/1	200	B 34	2 x B14 1 x B29	1890.00
163/2	350	B 45	2 x B14 1 x B29	2140.00
163/3	500	B 60	2 x B14 1 x B29	2440.00
163/4	750	B 60	2 x B29 1 x B14	3390.00
163/5	1000	B 70	2 x B29 1 x B14	3810.00
163/6	2000	B 70	2 x B29 1 x B14	5590.00
163/7	3000	B 70	2 x B29 1 x B14	8390.00
163/8	4000	B 70	2 x B29 1 x B14	10190.00
163/9	6000	B 70	2 x B29 1 x B14	14190.00





**164 FLASK BOILING ROUND BOTTOM**

Cat No.	Cap. ml	Price
164/1	5	80.00
164/2	10	80.00
164/3	25	100.00
164/4	50	120.00
164/5	100	130.00
164/6	150	150.00
164/7	250	160.00
164/8	500	250.00
164/9	1000	370.00

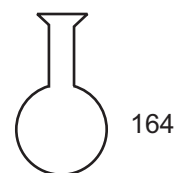

**165. FLASK CONICAL NARROW MOUTH**

Cat No.	Cap. ml	Price
165/1	5	70.00
165/2	10	90.00
165/3	25	100.00
165/4	50	110.00
165/5*	100	150.00
165/6*	150	190.00
165/7*	250	190.00
165/8*	500	220.00
165/9*	1000	390.00
165/10*	2000	650.00
165/11	3000	1850.00
165/12	5000	3000.00

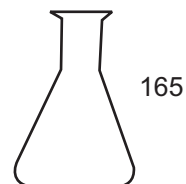

\* GRADUATED

**166. FLASK KHELDAHL ROUND BOTTOM LONG NECK**

Cat No.	Cap. ml.	Price
166/1	10	110.00
166/2	30	140.00
166/3	100	270.00
166/4	300	426.00
166/5	500	836.00
166/6	800	1036.00

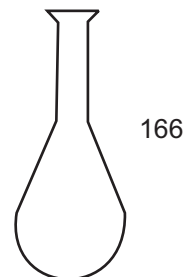

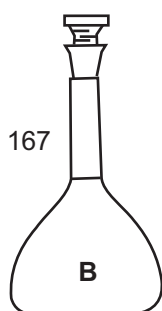

**167. FLASK VOLUMETRIC WITH INTERCHANGEABLE GLASS STOPPER CLASS B**

Cat No.	Cap. ml.	Stopper size	Tolerance ml.	Price
167/1*	1-5	10/13	0.02	350.00
167/2	10	10/13	0.05	330.00
167/3	25	10/13	0.08	350.00
167/4	50	10/13	0.12	350.00
167/5	100	10/13	0.20	390.00
167/6	200	14/15	0.30	420.00
167/7	250	14/15	0.30	490.00
167/8	500	19/20	0.50	640.00
167/9	1000	19/20	0.80	990.00
167/10	2000	19/20	1.20	1890.00

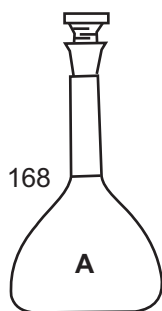

**168. FLASK VOLUMETRIC WITH INTERCHANGEABLE GLASS STOPPER A CLASS WITH WORK CERTIFICATE**

Cat No.	Cap. ml.	Stopper size	Tolerance ml.	Price
168/1*	1-5	10/13	0.010	1050.00
168/2	10	10/13	0.025	830.00
168/3	25	10/13	0.040	770.00
168/4	50	10/13	0.060	750.00
168/5	100	14/15	0.100	730.00
168/6	200	14/15	0.150	1050.00
168/7	250	14/15	0.150	1050.00
168/8	500	19/20	0.250	1330.00
168/9	1000	19/20	0.400	1950.00
168/10	2000	24/25	0.600	3790.00

\* 1-5ML FLASK ARE WIDE MOUTH TEST TUBE SHAPE





**FUNNELS**

**169. FUNNEL FILTER 60° ANGLE LONG STEM**

Cat No.	Dia mm	Price
169/1	12 - 18	70.00
169/2	25	90.00
169/3	50	90.00
169/4	65	115.00
169/5	75	125.00
169/6	100	180.00
169/7	125	400.00

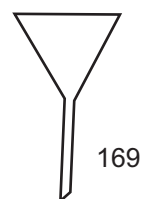

**170. FUNNEL POWDER SHORT STEM WITH OR WITHOUT CONE**

Cat No.	Dia. mm.	With Cone(C) Price	Without Cone Price
170/1	75	400.00	190.00
170/2	100	535.00	200.00
170/3	125	800.00	600.00
170/4	150	950.00	700.00
170/5	200	1500.00	1200.00
170/6	250	2050.00	1800.00

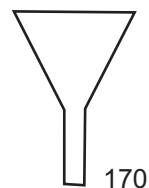

**171. FUNNEL SEPARATING SPHERICAL WITH GLASS STOPCOCK**

Cat No.	Cap. ml.	Price
171/1	25	590.00
171/2	60	630.00
171/3	100-125	750.00
171/4	250	800.00
171/5	500	1050.00
171/6	1000	1750.00
171/7	2000	3450.00
171/8	3000	4500.00
171/9	5000	5400.00
171/10	10000	12300.00
171/11	20000	17400.00

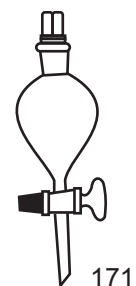

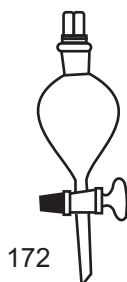

**172. FUNNEL SEPARATING SPHERICAL WITH PTFE PLUG STOPCOCK**

Cat No.	Cap. ml	Price
172/1	25	1290.00
172/2	60	1290.00
172/3	100 - 125	1590.00
172/4	250	1640.00
172/5	500	2340.00
172/6	1000	2990.00
172/7	2000	4390.00
172/8	3000	8890.00
172/9	5000	10590.00
172/10	10000	23790.00
172/11	20000	29590.00



**173. FUNNEL SEPARATING SPHERICAL WITH PTFE SCREWCOCK**

Cat No.	Cap. ml.	Price
173/1	25	590.00
173/2	60	630.00
173/3	100-125	750.00
173/4	250	850.00
173/5	500	1050.00
173/6	1000	1750.00
173/7	2000	3400.00



**174. FUNNELSEPARATING CONICAL WITH GLASS STOPCOCK**

Cat No.	Cap. ml.	Price
174/1	25	590.00
174/2	60	630.00
174/3	100 - 125	750.00
174/4	250	800.00
174/5	500	1050.00
174/6	1000	1750.00
174/7	2000	3400.00
174/8	3000	4500.00
174/9	5000	6000.00





**176. FUNNEL SEPARATING CONICAL WITH PTFE PLUG STOPCOCK**

Cat No.	Cap. ml.	Price
176/1	25	1370.00
176/2	60	1370.00
176/3	100-125	1610.00
176/4	250	1670.00
176/5	500	2290.00
176/6	1000	3390.00
176/7	2000	4890.00
176/8	3000	9640.00
176/9	5000	12590.00

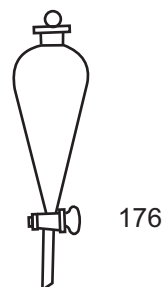

**177. FUNNEL SEPARATING CONICAL WITH PTFE SCREWCOCK**

Cat No.	Cap. ml.	Price
177/1	25	590.00
177/2	60	630.00
177/3	100-125	750.00
177/4	250	800.00
177/5	500	1050.00
177/6	1000	1750.00
177/7	2000	3400.00



**178. FUNNEL SEPARATING CYLINDRICAL WITH GLASS STOPCOCK**

Cat No.	Cap. ml.	Price
178/1	25	550.00
178/2	50	600.00
178/3	100	620.00
178/4	250	830.00
178/5	500	1050.00
178/6	1000	1400.00
178/7	2000	2300.00

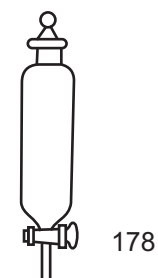





**179. FUNNEL SEPARATING CYLINDRICAL WITH PTFE PLUG STOPCOCK**

Cat No.	Cap. ml.	Price
179/1	25	1000.00
179/2	50	1200.00
179/3	100	1250.00
179/4	250	1290.00
179/5	500	1550.00
179/6	1000	2400.00
179/7	2000	3200.00

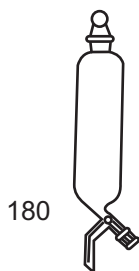

**180. FUNNEL SEPARATING CYLINDRICAL WITH PTFE SCREWCOCK**

Cat No.	Cap. ml	Price
180/1	25	550.00
180/2	50	600.00
180/3	100	620.00
180/4	250	830.00
180/5	500	1050.00
180/6	1000	1400.00
180/7	2000	2300.00



**181. FUNNEL SEPARATING CYLINDRICAL GRADUATED WITH GLASS STOPCOCK**

Cat No.	Cap. ml.	Price
181/1	25	750.00
181/2	50	800.00
181/3	100	850.00
181/4	250	1050.00
181/5	500	1400.00
181/6	1000	1800.00
181/7	2000	2800.00





**182. FUNNEL DROPPING OPEN TO GLASS STOPCOCK**

Cat No.	Cap. ml.	Price
182/1	25	450.00
182/2	50	470.00
182/3	100	560.00
182/4	250	700.00

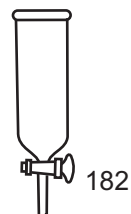

**183. FUNNEL DROPPING OPEN TOP GLASS STOP COCK / ROTAFLOW STOPCOCK WITH CONE**

Cat No.	Cap. ml.	Cone	Price
183/1	50	19/26	630.00
183/2	100	19/26	750.00
183/3	250	19/26	1100.00

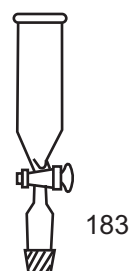

**184. FUNNEL DROPPING CYLINDRICAL WITH CONE AND SOCKET**

Cat No.	Cap. ml.	Socket	Cone	Price
184/1	20	10/19	10/19	690.00
184/2	25	14/23	14/23	690.00
184/3	50	14/23	14/23	740.00
184/4	100	14/23	14/23	870.00
184/5	100	19/26	19/26	890.00
184/6	250	19/26	19/26	1100.00
184/7	500	19/26	19/26	1430.00
184/8	1000	19/26	19/26	2600.00

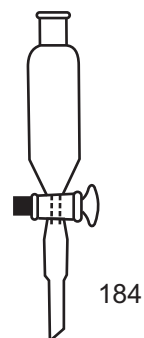

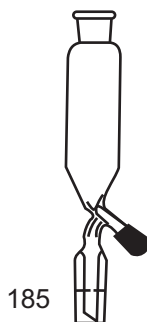

185

**185. FUNNEL DROPPING CYLINDRICAL PTFE SCREW COCK**

Cat No.	Cap. ml	Socket	Cone	Price
185/1	25	14/26	14/23	750.00
185/2	50	14/23	14/23	800.00
185/3	100	14/23	14/23	850.00
185/4	100	19/26	19/26	900.00
185/5	250	19/26	19/26	1200.00
185/6	500	19/26	19/26	1600.00
185/7	1000	19/26	19/26	2000.00



186

**186. FUNNEL DROPPING PEAR SHAPED STEM WITH CONE**

Cat No.	Cap. ml.	Socket	Cone	Price
186/1	25	14/23	14/23	750.00
186/2	50	14/23	14/23	800.00
186/3	50	19/26	19/26	800.00
186/4	100	14/23	14/23	850.00
186/5	100	19/26	19/26	850.00
186/6	250	19/26	19/26	1200.00
186/7	500	19/26	19/26	1600.00
186/8	500	24/29	24/29	1600.00
186/9	1000	19/26	19/26	2000.00
186/10	1000	24/29	24/29	2000.00

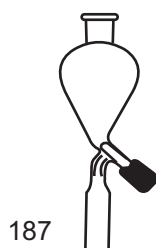

187

**187. FUNEL DROPPING PEAR SHAPED STEM WITH CONE PTFE SCREW COCK**

Cat No.	Cap. ml.	Socket	Cone	Price
187/1	50	14/23	14/23	750.00
187/2	100	14/23	14/23	800.00
187/3	100	19/26	19/26	850.00
187/4	250	19/26	19/26	1200.00
187/5	500	19/26	19/26	1600.00
187/6	1000	19/26	19/26	2000.00





### 188. PRESSURE EQUALISING FUNNEL SPHERICAL GLASS STOPCOCK

Cat No.	Cap. ml.	Socket	Cone	Price
188/1	25	14/23	14/23	1190.00
188/2	50	14/23	14/23	1290.00
188/3	100	19/26	19/26	1490.00
188/4	100	24/29	19/26	1490.00
188/5	100	29/32	24/29	1490.00
188/6	250	24/29	19/26	1790.00
188/7	250	34/35	24/29	1790.00
188/8	500	24/29	24/29	2000.00
188/9	500	34/35	24/29	2000.00
188/10	1000	34/35	39/32	2400.00

### 189. PRESSURE EQUALISING FUNNEL CYLINDRICAL GLASS STOPCOCK

Cat No.	Cap.ml	Socket	Cone	Price Plain	Price Graduated
189/1	25	14/23	14/23	1250.00	1350.00
189/2	50	14/23	14/23	1250.00	1400.00
189/3	100	19/26	19/26	1550.00	1800.00
189/4	250	24/29	19/26	1850.00	2000.00
189/5	500	24/29	19/26	2250.00	2400.00
189/6	1000	34/35	24/29	2400.00	2700.00

### 190. PRESSURE EQUALISING FUNNEL SPHERICAL PTFE SCREW COCK

Cat No.	Cap. ml.	Socket	Cone	Price
190/1	25	14/23	14/23	1190.00
190/2	50	14/23	14/23	1290.00
190/3	100	24/29	29/26	1490.00
190/4	250	24/29	19/26	1890.00
190/5	500	34/35	24/29	2400.00

### 191. PRESURE EQUALISING CYLINDRICAL PTFE SCREW COCK

Cat No.	Cap.ml.	Socket	Cone	PTFE Plunger STOP COCK	Price Graduated
191/1	25	14/23	14/23	1400.00	1890.00
191/2	50	14/23	14/23	1450.00	2090.00
191/3	100	19/26	19/26	1750.00	2490.00
191/4	250	24/29	19/26	2250.00	2890.00
191/5	500	24/29	19/26	2650.00	3490.00
191/6	1000	34/35	24/29	4250.00	5690.00

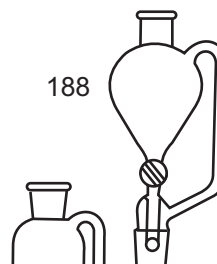

188

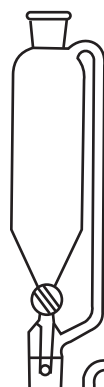

189

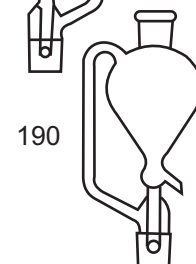

190



191

55





**192. SOLVENT RESERVOIR WITH PRESSURE  
EQUILISING FUNNEL**

Cat No.	Cap. ml.	Price
192/1	250	5200.00
192/2	500	6000.00
192/3	1000	8500.00

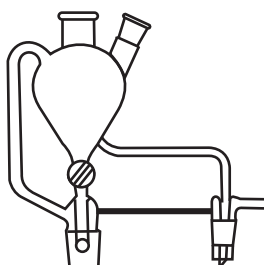

192





**GROUND - JOINTS**

**193. SOCKETS PLAIN SHANK SINGLE**

Cat No.	Socket	Shank Length mm	Price
193/1	5/13	100	150.00
193/2	7/16	100	150.00
193/3	10/19	100	150.00
193/4	12/21	100	150.00
193/5	14/23	100	150.00
193/6	19/26	100	170.00
193/7	24/29	100	170.00
193/8	29/32	100	210.00
193/9	34/35	100	250.00
193/10	40/38	100	410.00
193/11	45/40	100	490.00
193/12	50/42	100	590.00
193/13	55/44	100	690.00
193/14	60/46	100	1188.00



193

**194. SOCKETS PLAIN SHANK DOUBLE**

Cat No.	Socket	Shank Length mm	Price
194/1	10/19	80	230.00
194/2	12/21	80	250.00
194/3	14/23	80	270.00
194/4	19/26	80	290.00
194/5	24/29	80	310.00
194/6	29/32	100	410.00
194/7	34/35	100	490.00
194/8	40/38	100	690.00



194



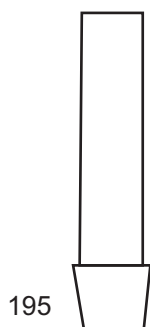

195

**195. CONES PLAIN END SINGLE**

Cat. No.	Cone	Shank Length mm	Price
195/1	5/13	100	150.00
195/2	7/16	100	150.00
195/3	10/19	100	150.00
195/4	10/21	100	150.00
195/5	14/23	100	150.00
195/6	19/26	100	170.00
195/7	24/29	100	170.00
195/8	29/32	100	210.00
195/9	34/35	100	250.00
195/10	40/38	100	410.00
195/11	45/40	100	490.00
195/12	50/42	100	590.00
195/13	55/44	100	690.00
195/14	60/46	100	1190.00



196

**196. CONES PLAIN END DOUBLE**

Cat No.	Cone	Shank Length mm	Price
196/1	10/19	80	230.00
196/2	12/21	80	250.00
196/3	14/23	80	270.00
196/4	19/26	80	290.00
196/5	24/29	80	310.00
196/6	29/32	100	410.00
196/7	34/35	100	490.00
196/8	40/38	100	690.00



197

**197. CONES, ANGLE DRIP SINGLE**

Cat No.	Cone	Shank Length mm	Price
197/1	10/19	100	170.00
197/2	14/23	100	190.00
197/3	19/26	100	210.00
197/4	24/29	100	230.00
197/5	29/32	100	310.00
197/6	34/35	100	390.00





**198. CONES, ANGLE DRIP, DOUBLE**

Cat No.	Cone	Shank Length mm	Price
198/1	10/19	80	270.00
198/2	14/23	80	310.00
198/3	19/26	80	370.00
198/4	24/29	80	410.00
198/5	29/32	100	540.00
198/6	34/35	100	690.00

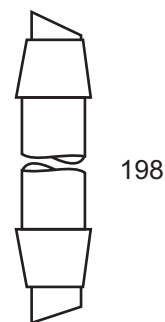

**199. CONICAL JOINTS GREASELESS HIGHLY POLISHED SUITABLE FOR VACUUM**

Cat No.	Joint	Price
199/1	10/19	590.00
199/2	14/23	590.00
199/3	19/26	740.00
199/4	24/29	740.00
199/5	29/32	890.00
199/6	34/35	1090.00

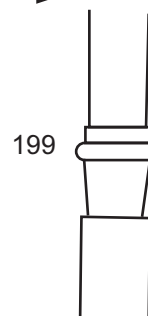

**200. JOINTS SPHERICAL CUP**

Cat No.	Cup	Price
200/1	S 13	580.00
200/2	S 19	700.00
200/3	S 29	980.00
200/4	S 35	1080.00
200/5	S 41	2380.00
200/6	S 51	3180.00

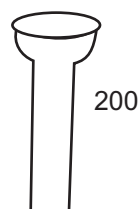

**201. SPHERICAL JOINTS BALL**

Cat No.	Ball	Price
201/1	S 13	290.00
201/2	S 19	350.00
201/3	S 29	490.00
201/4	S 35	540.00
201/5	S 41	1090.00
201/6	S 51	1590.00





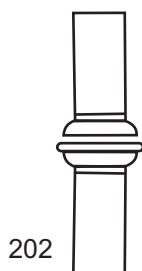

202



203

**202. JOINTS SPHERICAL GREASELESS HIGHLY POLISHED SUITABLE FOR VACUUM**

Cat. No.	Joints	Price
202/1	S 13	990.00
202/2	S 19	1240.00
202/3	S 29	1490.00
202/4	S 35	1890.00

**203. SPHERICAL JOINTS CLIPS**

Cat No.	Joints	Price
203/1	S 13	650.00
203/2	S 19	750.00
203/3	S 29	1000.00
203/4	S 35	1150.00
203/5	S 41	1200.00
203/6	S 51	2200.00





**PIPETTES**

**204. PIPETTES VOLUMETRIC ONE MARK CLASS B**

Cat No.	Cap. ml.	Tolerance	Price
204/1	1	0.015	160.00
204/2	2	0.020	160.00
204/3	5	0.030	200.00
204/4	10	0.040	220.00
204/5	15	0.050	280.00
204/6	20	0.060	300.00
204/7	25	0.060	320.00
204/8	50	0.100	330.00
204/9	100	0.160	440.00

**205. PIPETTES VOLUMETRIC ONE MARK CLASS A WITH WORK CERTIFICATE**

Cat No.	Cap. ml.	Tolerance	Price
205/1	1	0.007	350.00
205/2	2	0.010	350.00
205/3	5	0.015	400.00
205/4	10	0.020	470.00
205/5	15	0.020	600.00
205/6	20	0.030	590.00
205/7	25	0.030	640.00
205/8	50	0.050	740.00
205/9	100	0.080	1100.00

**206. PIPETTE PASTEURE PLAIN WITH BULB**

Cat No.	dia mm	Length (inch)	Price with rubberbulb	Price without rubberbulb
206/1	7-8	6-8	30.00	40.00
206/2	7-8	8-10	40.00	52.00
206/3	7-8	10-12	45.00	55.00

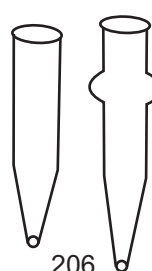
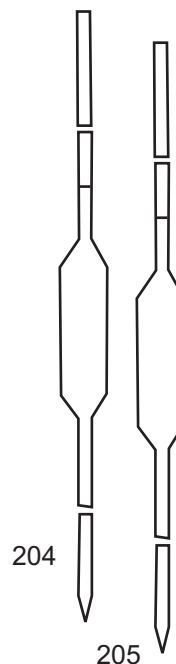



207

**207. PIPETTES MEASURING FOR DELIVERY FROM O MARK AT TOP TO THE GRADUATION MARK CLASS A MOHR/SEROLOGICAL TYPE**

Cat. No.	Cap. ml.	Sub. Div	Tolerance	Price
207/1	0.1	0.010	0.006	550.00
207/2	0.2	0.010	0.006	550.00
207/3	0.5	0.010	0.006	600.00
207/4	1.0	0.010	0.006	440.00
207/5	1.0	0.100	0.006	440.00
207/6	2.0	0.020	0.010	490.00
207/7	2.0	0.100	0.010	490.00
207/8	5.0	0.050	0.030	540.00
207/9	5.0	0.100	0.030	540.00
207/10	10.0	0.100	0.050	590.00
207/11	25.0	0.200	0.100	690.00

**208. PIPETTES DRAIN OUT O AT JET, CLASS B TO PRESET VOLUME WITHOUT EJECTION OF LAST DROP**

Cat No.	Cap. ml.	Sub.Div.	Tolerance	Price
208/1	0.1	0.005	0.01	200.00
208/2	0.1	0.010	0.01	200.00
208/3	0.2	0.005	0.01	200.00
208/4	0.2	0.010	0.01	200.00
208/5	0.5	0.010	0.01	350.00
208/6	0.5	0.020	0.01	350.00
208/7	1.0	0.010	0.01	160.00
208/8	1.0	0.100	0.01	160.00
208/9	2.0	0.020	0.02	170.00
208/10	2.0	0.100	0.02	170.00
208/11	5.0	0.050	0.05	200.00
208/12	5.0	0.10	0.05	200.00
208/13	10.0	0.100	0.10	230.00
208/14	25.0	0.200	0.20	320.00



208





**SINTERED-WARE**

**209. GOOCH CRUCIBLES WITH SINTERED DISC POROSITY G1 TO G4**

Cat No.	Cap. ml.	Disc. Dia mm	Price
209/1	15	20	250.00
209/2	30	30	300.00
209/3	50	40	400.00



**210. GOOCH CRUCIBLES WITH SINTERED DISC AND CONEPOROSITY G1 TO G4**

Cat No.	Cap. ml.	Cone	Price
210/1	20	29/32	620.00
210/2	35	34/35	790.00
210/3	50	40/25	890.00

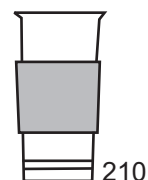

**211. BUCHNER FILTER FUNNELS WITH SINTERED DISC G1 TO G4**

Cat No.	Cap. ml.	Disc Dia mm	Price
211/1	35	30	390.00
211/2	80	40	650.00
211/3	200	65	1400.00
211/4	500	90	2500.00
211/5	1000	120	5200.00
211/6	2000	140	8000.00

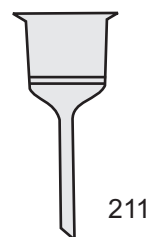

**212. BUCHNER FILTERS WITH SINTERED DISC G1-G4 WITH CONE JOINT**

Cat No.	Cap.m.	Disc.dia.mm.	Cone	Price
212/1	35	30	19/26	890.00
212/2	35	30	24/29	890.00
212/3	80	40	19/26	1490.00
212/4	80	40	24/29	1490.00
212/5	200	65	24/29	2290.00
212/6	200	65	29/32	2290.00
212/7	500	90	24/29	4490.00
212/8	500	90	29/32	4490.00
212/9	1000	125	34/35	8000.00
212/10	1000	125	35/40	8000.00

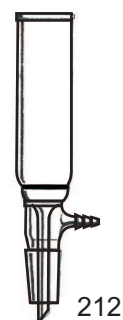

\* PLEASE SPECIFY POROSITY G1-G4 WHILE PLACING ORDER



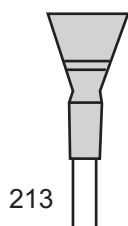

213

**213. SEMI MICRO CONICAL FILTERS WITH SINTERED DISC POROSITY G1-G4 WITH CONE**

Cat No.	Funnel Dia	Disc. Dia.	Cone	Price
213/1	30	10	10/19	690.00
213/2	30	10	14/23	690.00
213/3	45	20	19/26	790.00
213/4	80	30	19/26	990.00



214

**214. MICRO FILTER ASSEMBLY - VACUUM FILTER HOLDERS WITH GRADUATED CUP SINTERED BASE AND CLAMP**

Cat No.	Disc. size mm	Price
214/1	13	6000.00
214/2	25	7000.00
214/3	47	9000.00

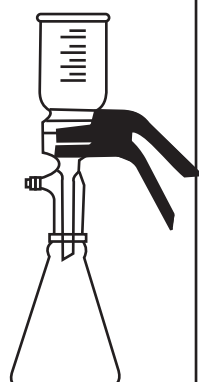

215

**215. MICRO FILTER ASSEMBLY - VACUUM FILTER HOLDER WITH GRADUATED CUP, SINTERED BASE WITH GROUP JOINT, CLAMP AND CONE FLASK**

Cat No.	Disc. Size mm	Flask Size mm	Price
215/1	25	1000	9500.00
215/2	47	1000	11500.00





**STIRRERS**

**216. STIRRER SEMI MICRO SCREW TYPE**

Cat No.	Shaft Dia mm	Shaft Lengthmm	Price
216/1	5	270	300.00

**217. LINKS STIRRERS**

Cat No.	Shaft Dia mm	Shaft Length mm	Socket To Pass	Price
2171	6	450	24/29	600.00
217/2	6	600	24/29	600.00
217/3	8	450	29/32	600.00
217/4	8	600	29/32	700.00

**218. COLLAPSIBLE PADDLE STIRRER**

Cat No.	Shaft Dia mm	Shaft Length mm	Socket To Pass	Price
218/1	6	450	24/29	600.00
218/2	6	500	24/29	600.00
218/3	8	450	29/32	850.00
218/4	8	600	29/32	930.00

**219. FIXED PADLES STIRRER**

Cat No.	Shaft Dia mm	Shaft length mm	Socket To pass	Price
219/1	6	600	55/44	750.00
219/2	11	750	100 Flange mm	1100.00

**220. ANCHOR STIRRER HALF MOON**

Cat No.	Shaft Dia mm	Shaft Length mm	Price
220/1	6	450	850.00
220/2	6	600	950.00
220/3	11	750	1200.00

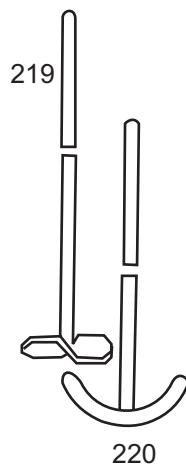
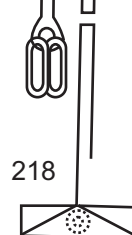
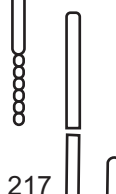



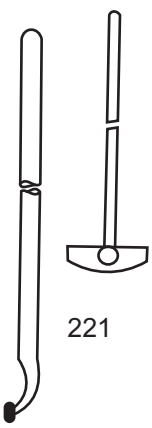



221

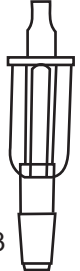

222



223



224

**221. STIRRER WITH BUTTON TO HOLD PTFE BLADE**

Cat No.	Shaft Dia mm	Shaft Length mm	Price
221/1	6	450	250.00
221/2	6	600	300.00
221/3	8	400	280.00
221/4	8	600	350.00
221/5	11	600	550.00
221/6	11	750	600.00

**222. PTFE BLADE FOR BUTTON STIRRER**

Cat No.	Blade with mm	Socket To Pass	Price
222/1	50	19/26	295.00
222/2	75	24/29	450.00
222/3	100	34/35	600.00
222/4	125	34/35	696.00
222/5	150	55/44	950.00

**223. MERCURY/OIL SEAL, GLANDS WITH PTFE WASHER**

Cat No.	Cone Size	Shaft Dia. mm	Price
223/1	19/26	6	900.00
223/2	24/29	6 - 8	1100.00
223/3	29/32	8	1200.00
223/4	29/32	11	1400.00
223/5	34/35	11	1600.00

**224. GLASS STIRRING ROD**

Cat No.	Dia mm	Length (inch)	Price
224/1	5-6	200	40.00
224/2	5-6	300	45.00
224/3	7-8	200	50.00
224/4	7-8	300	60.00





**225. GLASS SYRINGE STIRRER WITH PTFE BLADE**

Cat No.	Size ml.	Price
225/1	10	2990.00
225/2	20	3590.00

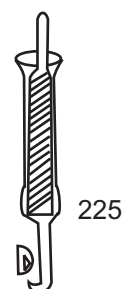

**226. MERCURY SEAL WITH GROUND SLEEVE GLAND SCREW CAP AND PTFE WASHER**

Cat No.	Shaft Dia mm	Cone	Price
226/1	6	19/26	1540.00
226/2	6-8	24/29	1740.00
226/3	11	29/32	2290.00
226/4	11	34/35	2590.00

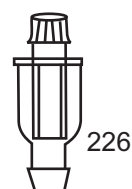

**227. STUFFING BOX GLANDS PTFE WITH O RINGS**

Cat No.	Shaft Dia mm	Cone	Price
227/1	5-6	10/19	590.00
227/2	5-6	14/23	640.00
227/3	6-8	19/26	690.00
227/4	6-11	24/29	940.00
227/5	8-11	29/32	1140.00
227/6	8-11	34/35	1240.00
227/7	8-11	40/45	1690.00
227/8	8-11	55/50	3390.00



**228. STUFFING BOX WITH PTFE CONE AND BRASS PULLEY**

Cat No.	Shaft Dia mm	Cone	Price
228/1	5-6	14/23	2390.00
228/2	6-8	19/26	2590.00
228/3	8-11	24/29	2890.00
228/4	8-11	29/32	3290.00
228/5	8-11	34/35	3490.00

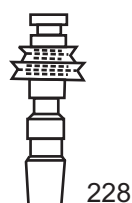

\* ALL PTFE PULLEY WITH CONE REFER PTFE PRODUCTS







**STOPCOCKS**

**229. STOPCOCKS STRAIGHT BORE**



229

Cat No.	Bore mm	Side Arm mm	Price
229/1	2	8	496.00
229/2	3	9	590.00
229/3	4	10	696.00
229/4	6	10	790.00
229/5	8	12	1190.00
229/6	10	15	2196.00

**230. STOPCOCKS STRAIGHT BORE WITH PTFE PLUG**



230

Cat No.	Bore mm	Side Arm mm	Price
230/1	2	8	850.00
230/2	4	10	1200.00
230/3	6	12	1400.00

**231. STOPCOCKS STRAIGHT BORE CAPILLARY LIMB**

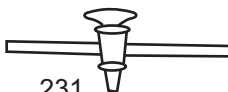

231

Cat No.	Bore mm	Side Arm mm	Price
231/1	2	7	596.00
231/2	3	8	794.00

**232. STOPCOCKS SINGLE OBLIQUE BORE**



232

Cat No.	Bore mm	Side Arm mm	Price
232/1	2	8	596.00
232/2	4	10	796.00
232/3	6	10	896.00
232/4	8	12	1549.00
232/5	10	15	2390.00

**233. STOPCOCK PTFE SCREW COCK**

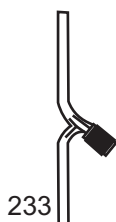

233

Cat No.	Bore mm	Side arm mm	Price
233/1	2-3	8	294.00
233/2	4-5	11	794.00
233/3	8-10	15	1494.00





**234. STOPCOCK PTFE SCREWCOCK CAPILARY BORE**

Cat No.	Bore mm	Side Arm mm	Price
234/1	2	7	396.00



**235. STOPCOCK DOUBLE OBLIQUE Y BORE**

Cat No.	Bore mm	Side Arm mm	Price
235/1	2	8	1196.00
235/2	4	10	1390.00
235/3	6	10	1590.00
235/4	8	12	2396.00

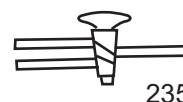

**236. STOPCOCK DOUBLE OBLIQUE Y BORE PTFE PLUG**

Cat No.	Bore mm	Side Arm mm	Price
236/1	2	8	2596.00
236/2	4	10	3394.00

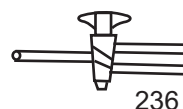

**237. STOPCOCK 'T' BORE**

Cat No.	Bore mm	Side Arm mm	Price
237/1	2	8	1044.00
237/2	4	10	1244.00
237/3	6	10	1444.00
237/4	8	12	2444.00

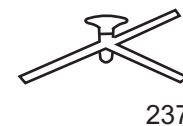

**238. STOPCOCK 'T' BORE PTFE PLUG**

Cat No.	Bore mm	Side Arm mm	Price
238/1	2	8	2390.00
238/2	4	10	2990.00



**239. STOPCOCK V BORE (120°)**

Cat No.	Bore mm	Side Arm mm	Price
239/1	2	8	1095.00
239/2	4	10	1290.00

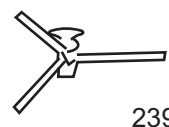

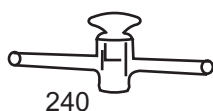

**240. STOPCOCK HIGH VACUUM STRAIGH 'T' BORE WITH HOLLOW PLUG**

Cat No.	Bore mm	Side Arm mm	Price
240/1	2	8	1180.00
240/2	4	10	1390.00
240/3	6	10	1596.00
240/4	8	12	2196.00
240/5	10	15	3290.00

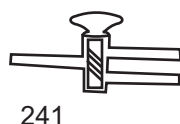

**241. STOPCOCK HIGH VACUUM DOUBLE OBLIQUE 'Y' BORE HOLLOW PLUG**

Cat No.	Bore mm	Side Arm mm	Price
241/1	2	8	2594.00
241/2	4	10	3394.00
241/3	6	10	4594.00

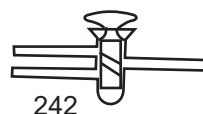

**242. STOPCOCK HIGH VACUUM DOUBLE OBLIQUE 'Y' BORE WITH VACUUM MERCURYCUP HOLLOW PLUG**

Cat No.	Bore mm	Side Arm mm	Price
242/1	2	8	3990.00
242/2	4	10	4796.00

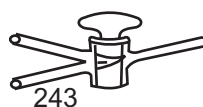

**243. STOPCOCK HIGH VACUUM T BORE WITH HOLLOW PLUG**

Cat No.	Bore mm	Side Arm mm	Price
243/1	2	8	2996.00
243/2	4	10	1190.00
243/3	6	10	2596.00



**244. STOPCOCK HIGH VACUUM V BORE WITH HOLLOW PLUG**

Cat No.	Bore mm	Side Arm mm	Price
244/1	2	8	1590.00
244/2	4	10	2190.00
244/3	6	10	2790.00





**245. STOPCOCK HIGH VACUUM RIGHT ANGLE LOWER**

Cat No.	Bore mm	Side Arm mm	Price
<b>LIMB VERTICAL HOLLOW PLUG</b>			
245/1	2	8	990.00
245/2	4	10	1290.00
245/3	6	10	1390.00
245/4	8	12	2090.00
245/5	10	15	2990.00

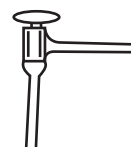

245

**246. STOPCOCK HIGH VACUUM RIGHT ANGLE LOWER**  
**LIMB HORIZONTAL HOLLOW PLUG**

Cat No.	Bore mm	Side Arm mm	Price
246/1	2	8	1090.00
246/2	4	10	1290.00
246/3	6	10	1590.00



246

**247. STOPCOCK HIGH VACUUM 3 LIMBS LOWER LIMB**  
**VERTICAL HOLLOW PLUG**

Cat No.	Bore mm	Side Arm mm	Price
247/1	2	8	1290.00
247/2	4	10	1290.00
247/3	6	10	1790.00
247/4	8	12	2490.00

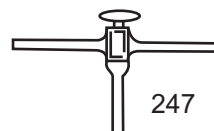

247





**STOPPERS**

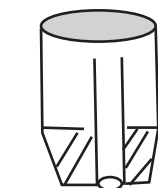

248

**248. STOPPER WITH CONE AND INSIDE TUBE**

Cat No.	Cone	Price
248/1	14/23	390.00
248/2	19/26	590.00
248/3	24/29	790.00

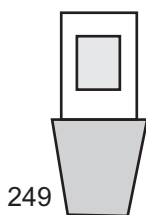

249

**249. STOPPER HOLLOW ENDS CLOSED INTERCHANGEABLE**

Cat No.	Cone	Price
249/1	7/11	50.00
249/2	10/19	50.00
249/3	12/21	60.00
249/4	14/15	60.00
249/5	14/23	60.00
249/6	19/26	70.00
249/7	24/29	75.00
249/8	24/20	75.00
249/9	29/32	100.00
249/10	34/35	150.00



250

**250. STOPPER HEXOGONAL HOLLOW ENDS CLOSED INTERCHANGEABLE**

Cat No.	Cone	Price
250/1	7/11	50.00
250/2	10/19	50.00
250/3	12/21	60.00
250/4	14/15	60.00
250/5	14/23	60.00
250/6	19/26	70.00
250/7	24/29	75.00
250/8	24/20	75.00
250/9	29/32	100.00
250/10	34/35	150.00





**251. STOPPER HOLLOW WITH PENNY HEAD CLOSED ENDS INTERCHANGEABLE**

Cat No.	Cone	Price
251/1	7/11	100.00
251/2	10/19	100.00
251/3	12/21	100.00
251/4	14/15	100.00
251/5	14/23	100.00
251/6	19/26	110.00
251/7	24/20	120.00
251/8	24/29	120.00
251/9	29/32	150.00
251/10	34/35	190.00
251/11	40/38	550.00
251/12	45/40	650.00
251/13	55/44	870.00

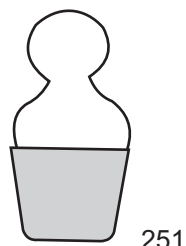

**252. STOPPER SOLID PENNY HEAD INTERCHANGEABLE**

Cat No.	Cone	Price
252/1	7/11	120.00
252/2	10/13	120.00
252/3	14/15	185.00
252/4	19/17	200.00
252/5	24/29	240.00
252/6	29/32	300.00

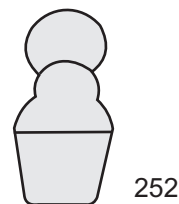

**253 SPRAYS FOR CHROMATOGRAPHY WITH RUBBER BULB**

Cat No.	Cap. ml.	Joint	Price
253/1	(Concial)100	24/29	890.00
253/2	(Conical)250	24/29	990.00
253/3	(F.B.) 50	Plain	990.00
253/4	(F.B.) 100	Plain	990.00
253/5	(F.B.) 250	Plain	940.00

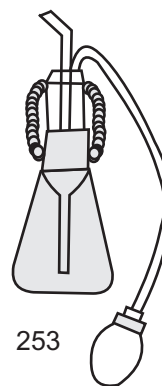



**TUBES**

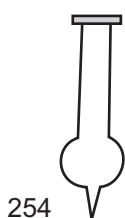

254

**254. TUBES ABSORPTION CALCIUM CHLORIDE STRAIGHT WITH ONE BULB**

Cat No.	OD x Length mm	Price
254/1	12 x 100	178.00
254/2	15 x 125	188.00
254/3	18 x 150	198.00
254/4	20 x 200	210.00

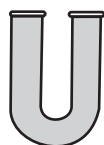

255

**255. TUBES ABSORPTION CALCIUM CHLORIDE U SHAPE PLAIN**

Cat No.	OD x Length mm	Price
255/1	12 x 100	300.00
255/2	15 x 125	320.00
255/3	18 x 150	340.00
255/4	20 x 200	400.00



256

**256. TUBES ABSORPTION CALCIUM CHLORIDE U SHAPE WITH SIDE TUBE**

Cat No.	OD x Length mm	Price
256/1	12 x 100	330.00
256/2	15 x 125	390.00
256/3	18 x 150	490.00
256/4	20 x 200	540.00

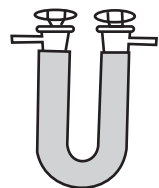

257

**257. TUBES ABSORPTION CALCIUM CHLORIDE U SHAPE WITH SIDE TUBE AND INTERCHANGEABLE STOPPER**

Cat No.	OD x Length mm	Joint	Price
257/1	12 x 100	10/19	795.00
257/2	15 x 125	14/23	844.00
257/3	18 x 150	14/23	940.00
257/4	20 x 200	19/26	1190.00





**258. ABSORPTION TOWER PLAIN TUBULAR AT BASE**

Cat No.	OD x Length mm	Price
258/1	40 x 250	1990.00
258/2	50 x 300	2290.00

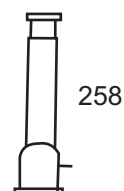

**259. ABSORPTION TOWER WITH STOPPER AND STOPCOCK**

Cat No.	OD x Length mm	Price
259/1	40 x 250	2290.00
259/1	50 x 300	2396.00

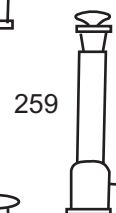

**260. TUBES ABSORPTION MIDVALVE WITH GROUND STOPPER LIGHT WEIGHT**

Cat No.	OD x Length mm	Joint	Price
260/1	40 x 130	14 x 23	1190.00

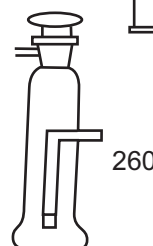

**261. TUBES CENTRIFUGES PLAIN WITH RIM**

Cat No.	Cap. ml.	OD x Length mm	Price
261/1	12	16 x 110	60.00
261/2	15	17 x 120	70.00

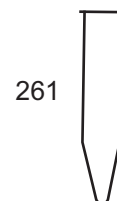

**262. TUBES CENTRIFUGES WITH RIM GRADUATED**

Cat No.	Cap. ml.	OD x Length mm	Price
262/1	15	17 x 120	150.00
262/2	50	29 x 135	200.00



**263. TUBES CENTRIFUGES PLAIN STOPPERED**

Cat No.	Cap. ml.	OD x Length mm	Joint	Price
263/1	15	17 x 120	14/15	220.00

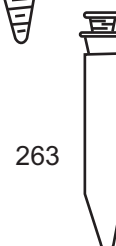





264

265

266

267

268

269

**264. TUBES CENTRIFUGES STOPPERED GRADUATED**

Cat No.	Cap. ml.	OD X Length mm	Price
264/1	15	17 x 120	450.00
264/2	50	29 x 135	600.00

**265. TUBES CENTRIFUGES SCREW CAP PLAIN WITH RUBBER LINER**

Cat No.	Cap. ml.	OD x Length mm	Price
265/1	3	12 x 75	210.00
265/2	5	12 x 100	210.00
265/3	15	15 x 150	300.00
265/4	25	22 x 150	350.00

**266. TUBES CENTRIFUGES SHORT CONICOL BOTTOM POUR OUR THICK WALLED**

Cat No.	Cap. ml	OD x length mm	Mark ml plain	Price
266/1	40	29 x 116	Plain	210.00
266/2	40	29 x 116	0-10 x 0.5 10-40 x 1	360.00

**267. TUBES CONNECTION STRAIGHT SHAPE THICK**

Cat No.	OD x Length mm	Price
267/1	6 x 40	100.00
267/2	8 x 50	110.00
267/3	10 60	120.00

**268. TUBES CONNECTION T SHAPED THICK**

Cat No.	OD x Length mm	Price
268/1	6 x 40	120.00
268/2	8 x 50	140.00
268/3	10 x 60	150.00

**269. TUBES CONNECTION Y OR U SHAPE THICK**

Cat No.	OD x Length mm	Price
269/1	6 x 40	168.00
269/2	8 x 50	200.00
269/3	10 x 50	250.00





**270. TUBES MELTING POINT CAPILLARY**

Cat No.	OD x Length	Price/Pack
270/1	1-1.5 x Ends Open 4"	140.00
270/2	1-1.5 x One end closed 4"	150.00
270/3	1-1.5 x Ends Open 12"	890.00

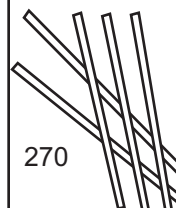

**271. TUBES MELTING POINTS THIELS**

Cat No.	OD x Length mm	Price
271/1	18 x 125	250.00
271/2	18 x 150	390.00
271/3	25 x 150	444.00



**272 TUBES TUMBURG WITH STOPPER**

Cat No.	Tube Cap. ml.	Joint	Price
272/1	6	14/23	590.00
272/2	20	19/26	1120.00

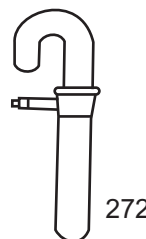

**273. TEST TUBES ROUND BOTTOM WITH OR WITHOUT RIM**

Cat No.	OD x Length mm	Price / each
273/1	10 x 75	10.00
273/2	12 x 75	10.50
273/3	12 x 100	14.00
273/4	15 x 125	18.00
273/5	15 x 150	20.00
273/6	18 x 150	22.00
273/7	25 x 100	35.00
273/8	25 x 150	40.00
273/9	25 x 200	50.00
273/10	32 x 200	80.00
273/11	38 x 200	90.00

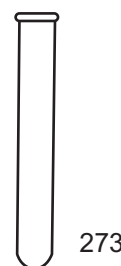



**274. TEST TUBES STOPPERED**

Cat No.	Cap. ml.	OD x Ht.mm	Joint	Price
274/1	5	12 x 100	10/13	168.00
274/2	10	16 x 125	14/15	180.00
274/3	15	16 x 150	14/15	190.00
274/4	25	22 x 150	19/17	250.00
274/5	50	26 x 200	24/20	350.00

**275. TEST TUBES STOPPERED GRADUATED**

Cat No.	Cap.ml.	OD x Ht.mm	Joint	Price
275/1	5	12 x 100	10/13	210.00
275/2	10	16 x 125	14/15	245.00
275/3	25	22 x 150	19/17	350.00
275/4	50	26 x 200	24/20	410.00

**276. TUBES CULTURE MEDIA ROUND BOTTOM WITH SCREW CAP AND RUBBER LINER**

Cat No.	Cap. ml.	OD x Length mm	Price
276/1	5	16 x 75	46.00
276/2	10	16 x 125	60.00
276/3	30	25 x 100	86.00
276/4	60	25 x 200	90.00

**277. TUBES CULTURE MEDIA FLAT BOTTOM WITH SCREW CAP AND RUBBER LINER**

Cat No.	Cap. ml.	OD x Length mm	Price
277/1	5	16 x 50	46.00
277/2	15	25 x 57	60.00
277/3	30	25 x 95	86.00

**278. SAMPLE BOTTLE / VIAL ORDINARY GLASS**

Cat No.	Cap. ml.	Price
278/1	2 - 3	14.00
278/2	5	16.00
278/3	10	22.00
278/4	15	34.00
278/5	20	40.00

**279. TEST TUBES SCREW CAP GRADUATED WITH RUBBER PTFE**

Cat No.	Cap.ml.	OD x Length mm	Price
279/1	5	12 x 100	236.00
279/2	10	16 x 125	276.00
279/3	25	25 x 150	376.00
279/4	50	25 x 200	496.00

PTFE TEST TUBES WITH SCREW CAP ALSO AVAILABLE.





**ASSEMBLIES**

280. SOLVENT RECOVERY ASSEMBLY Price  
 a) F.B. Flask 250 ml  
 b) Plain body extractor  
 c) Coil Condenser 150 mm 3290.00



281. VACUUM DISTILLATION UNIT Price  
 Reaction vessel 20000 ml  
 100 mm flange  
 Flange Lid 100mm with five necks  
 Clip 100mm  
 Gas inlet tube  
 Thermometer pocket  
 Stopper  
 Recovery bend  
 Thermometer with PTFE cone  
 Stirrer guide  
 Ground sleeve gland  
 Anchor stirrer 750mm  
 Receiver adapter  
 Intermediate flask 500ml  
 Vacuum control stopcock  
 Stopcock adaptor  
 R.B. flask 2 neck 200ml  
 Vacuum release stopcock 58000.00

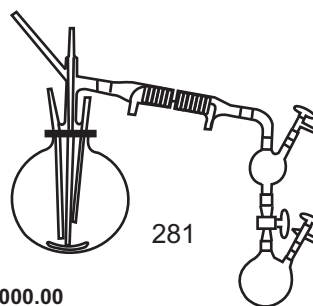

282 DISTILLATION UNIT Price  
 Reaction vessel 10000 ml  
 100mm flange  
 Flange Lid 100mm with five necks  
 Clip 100mm  
 Gas inlet tube  
 Stopper  
 Stirrer guide  
 Ground sleeve gland  
 Anchor stirrer 750mm  
 Still head  
 Double coil condenser 230mm  
 Receiver adapter  
 IR B. Flask 200ml  
 Thermometer pocket 55990.00

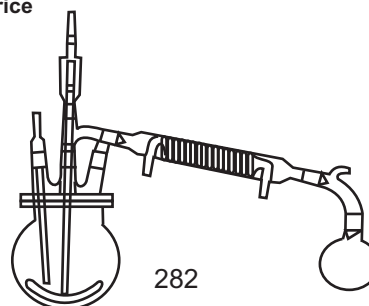





**286. SOXHLET EXTRACTION LIQUID DOWNWARD DISPLACEMENT**

In this heavy faced solvent is discharged from a condenser into the top of the solution to be extracted, the solvent in this instance sinks through the solution & both solvent & extract then return to the flask via a tube from the bottom to the extractor body.

- |    |  |                  |
|----|--|------------------|
| a) | Extractor 60ml. B34/35 & B34/29<br>Baffle distributor flask 150 ml 24/29<br>condenser allihin 200mm            | Price<br>5190.00 |
| b) | Extractor 400ml B35/35 & B34/29<br>sintered disc distributor flask 100ml<br>24/29 condenser allihin 200        | 8500.00          |
| c) | Extractor 1000ml 55/44 & 34/35<br>sintered disc distributor flask<br>2000 ml B34/35 condenser<br>Allihin 200mm | 11000.00         |

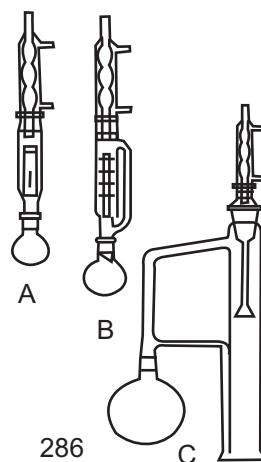

**287. SOXHLET EXTRACTION LIQUID UPWARD DISPLACEMENT**

This method allows light face solvent to enter the bottom of solution containing the extract, on emerging from the distributor air ascends through the heavy phase extracting the dissolved component & both the solvent & the extract then flow back into the flask

- |    |   |                  |
|----|---|------------------|
| a) | Extractor 100 ml<br>34/35 B24/29 sintered disc distributor<br>flask 150ml 24/29 condenser<br>davies 200mm | Price<br>8990.00 |
| b) | Extractor 200ml 34/35 & 34/29<br>sintered disc distributor flask<br>condenser davies 200mm                | 8990.00          |

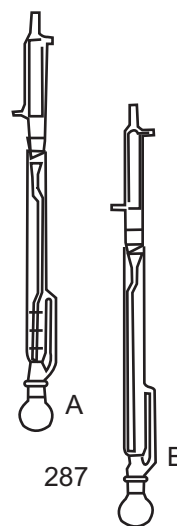



<p>288</p>	<b>288. UNIVERSAL KJELDAHL ASSEMBLY</b> Price										
	a) Kjeldahi flask 800 ml 24/29 or RB flask long neck 1000ml 24/29, multiple adapter dropping funnel 50ml. splash head pear sloping, receiving adapter straight, leibig condenser 200mm	4810.00									
	b) Metal stand and clamps	3590.00									
<p>289</p>	<b>289 DISTILLING APPARATUS, AMMONIA, WITH GRAHAM CONDENSER, INTERCHANGEABLE JOINT,</b>										
	<table border="1"> <thead> <tr> <th>Capacity ml</th> <th>Quantity Per Case</th> <th>Maximum * Price/PriceRs.</th> </tr> </thead> <tbody> <tr> <td>500</td> <td>2</td> <td>4900.00</td> </tr> </tbody> </table>	Capacity ml	Quantity Per Case	Maximum * Price/PriceRs.	500	2	4900.00				
Capacity ml	Quantity Per Case	Maximum * Price/PriceRs.									
500	2	4900.00									
<p>290</p>	<b>290 DISTILLING APPARATUS, WITH GRAHAM CONDENSER, INTERCHANGEABLE JOINTS, INTERCHANGEABLE STOPPER,</b>										
	<table border="1"> <thead> <tr> <th>Cap. ml</th> <th>Condenser Jacket mm</th> <th>Interchangeable joint</th> <th>Qty Per case</th> <th>Maximum * Price/Each Rs.</th> </tr> </thead> <tbody> <tr> <td>500</td> <td>200</td> <td>19/26</td> <td>2</td> <td>4500.00</td> </tr> </tbody> </table>	Cap. ml	Condenser Jacket mm	Interchangeable joint	Qty Per case	Maximum * Price/Each Rs.	500	200	19/26	2	4500.00
Cap. ml	Condenser Jacket mm	Interchangeable joint	Qty Per case	Maximum * Price/Each Rs.							
500	200	19/26	2	4500.00							
<p>291</p>	<b>291 Distilling Apparatus, with Friedrichs Condenser, Interchangeable Joint, Interchangeable Stopper,</b>										
	<table border="1"> <thead> <tr> <th>Cap. ml</th> <th>Overall Height mm</th> <th>Interchangeable joint</th> <th>Qty. Per Case</th> <th>Maximum* Price/Piece Rs.</th> </tr> </thead> <tbody> <tr> <td>2000</td> <td>350</td> <td>24/29</td> <td>2</td> <td>6750.00</td> </tr> </tbody> </table>	Cap. ml	Overall Height mm	Interchangeable joint	Qty. Per Case	Maximum* Price/Piece Rs.	2000	350	24/29	2	6750.00
Cap. ml	Overall Height mm	Interchangeable joint	Qty. Per Case	Maximum* Price/Piece Rs.							
2000	350	24/29	2	6750.00							





**292. SEMI MICRO KJELDAHL APPARATUS Price**

- a) In this apparatus reagents are introduced from the funnel which enter the solution below the surface thus eliminating the possibility of entrapment. The steam can be introduced via cone to aid the distillation process. Flask kjeldahi 50 ml or 100ml. distillation head funnel plug. leibig condenser 200 mm clip joint. 4990.00
- b) Metal stand and clamps 3590.00

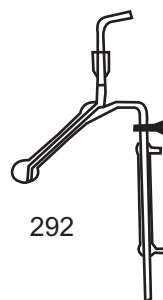

292

**293. MOISTURE DETERMINATION APPARATUS Price**

- a) Receiver 2ml x 0.5 ml. flask R.B. 250ml, leibig condenser 200 mm 2990.00
- b) Receiver 5ml or 7.5ml flask RB 500 ml and condenser 250 mm. 3390.00
- c) Receiver 10 ml x 0.1 ml RB flask 1000 ml and Leibig condenser 400 mm 3590.00
- d) Receiver 25ml. RB flask 1000 ml leibig condenser 400 mm 4390.00

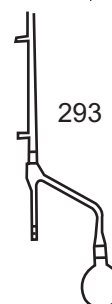

293







294

**294. MOISTURE DETERMINATION APPARATUS DEAN & STARK PATTERN FOR LIGHT ENTRAINERS WITH STOPCOCK**

a)	Receiver 2 ml x 0.05 ml Flask RB 250 ml Leibig condenser 200 mm	Price 2500.00
b)	Receiver 5ml or 7.5 ml x 0.1 ml Flask RB 500 ml Leibig condenser 250 mm	2600.00
c)	Receiver 10 ml x 0.1 ml Flask RB 1000 ml Leibig condenser 400mm	2900.00
d)	Receiver 25 ml x 0.2 ml Flask RB 1000 ml Leibig condenser 400 mm	3400.00

295

**295. ARSENIC DETERMINATION APPARATUS**

Bottle 100 ml	Price
Arsenic tubes with rubber bands	
Metal clip	600.00

296

**296. ARSENIC DETERMINATION APPARATUS GUTZEIT**

Bottle 10 ml	Price
Arsenic tubes with flange ends	
Bottle head with funnel	2400.00

297

**297. ARSENIC DETERMINATION APPARATUS**

Flask conical 100ml	Price
Absorption tube capillary	2200.00

84





**298. BECKMANN FREEZING POINT APPARATUS**

<b>Cat No.</b> 298/1	<b>Components</b> Comprising of outer jar with stainless steel cover and stirrer, jacketed inner tube with nickel stirrer and metal base plate without thermometers	<b>Price</b> 10990.00
-------------------------	--	--------------------------

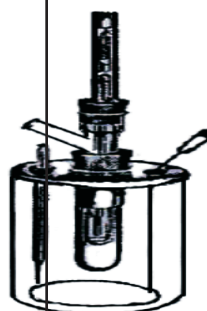

298

**299. MANIFOLD, VACUUM, GLASS STOPCOCK.**

Cat No.	No. of Ports	Price
299/1	3	5990.00
299/2	4	6990.00
299/3	5	9990.00
299/4	6	10990.00

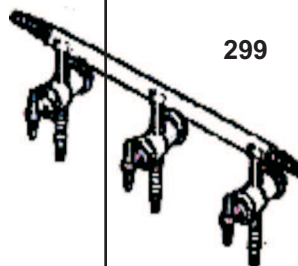

299

**300. SCHLENK LINE ASSEMBLY , VACUUM, DOUBLE OBLIQUE BORE GLASS STOPCOCK,**

Cat No.	No. of Ports	Price
300/1	3	17990.00
300/2	4	21990.00
300/3	5	25990.00
300/4	6	29990.00

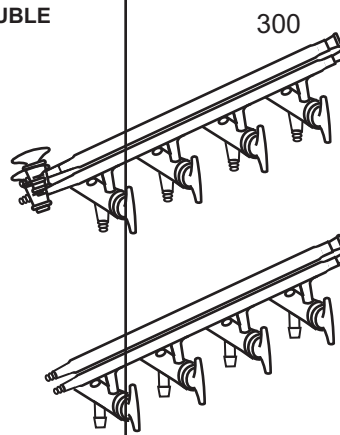

300





**PTFE PRODUCT**

PTFE Laboratory ware and accessories are designed for use under the most severe laboratory condition. SSC has NW gained expertise in the techniques used in fabrication and fashioning PTFE laboratory ware. It has an unmatched combination of chemical inertness, heat resistance, Low temperature toughness and non-adhesive qualities.

**CHEMICALLY INERT:** PTFE products is completely inert to all concentrations of corrosive reagents as boiling aque regia hydorfluric, nitric and sulphuric acids-alkalies, boiling hydrocarbons, ketones, estors and alcohols. It's only at elevated temperature and pressure that molten alkalies metals and certain halogenated chemical have some effect.

**NON CONTAMINATING:** PTFE laboratory products are poresfree from any contamination, imparts no odour, does not support growth of bacteria or fungi.

**EASY TO CLEAN:** The unique anti-adhesive properties of PTFE resists adhesion of practically all materials. Even the stickiest substance are easily removed (cleaned) to the last drop.

**UNBREAKABLE:** PTFE cannot be cracked or chipped by thermal or mechanical shock and not subject to stress cracing. For its inherent toughness it is unbreakable even at low temperature.

**HEAT-COLD RESISTANCE:** PTFE can with stand high temperature upto 2600 down through cryogenic range to 2000 C.

**OFFERS ITS ADDED ADVANTAGE OF PTFE LABORATORY PRODUCTS OF EXTRA SMOOTH SURFACE-HIGH UNIFORM DENSITY - CLASSIC DESIGNS-EASY TO HANDLE.**

<b>301. PTFE EVAPORATING DISHES</b>			
<b>Cat No.</b>	<b>OD x Ht</b>	<b>Price</b>	
<b>301/1</b>	<b>80 x 45</b>	<b>2190.00</b>	
<b>301/2</b>	<b>105 x 55</b>	<b>2390.00</b>	
<b>301/3</b>	<b>150 x 80</b>	<b>3390.00</b>	
<b>301/4</b>	<b>200 x 100</b>	<b>3790.00</b>	

301





**302. PTFE CONICAL FLASK WIDE MOUTH**

Cat. No.	Cap. ml.	Price Plain(P)	Price Screw Cap (SC)
302/1	25	950.00	1590.00
302/2	50	1300.00	2190.00
302/3	100	2000.00	3190.00
302/4	250	2200.00	3990.00
302/5	500	2600.00	7390.00

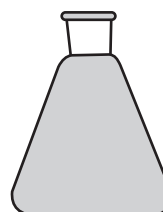

302

**303. PTFE MERCURY SEAL**

Cat No.	Cone Size	Price
303/1	B14	1850.00
303/2	B19	2100.00
303/3	B24	2400.00
303/4	B29	2900.00
303/5	B34	3300.00
303/6	B55	5290.00



303

**304. PTFE GAS WASH BOTTLE**

Cat No.	Cap. ml.	Price
304/1	125	4990.00
304/2	250	7390.00
304/3	500	9000.00

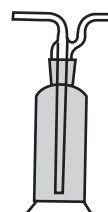

304





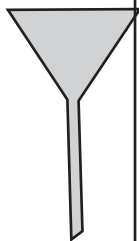

305



306



307

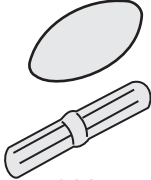

308

**305. PTFE FUNNEL 60°**

Cat No.	Dia - mm	Price
305/1	25	460.00
305/2	50	700.00
305/3	75	1100.00
305/4	100	1200.00

**306. PTFE WEIGHING BOTTLE WITH INTERCHANGEABLE STOPPER**

Cat No.	Cap. ml	Dia x Ht mm	Price
306/1	5	20 x 40	890.00
306/2	15	25 x 50	990.00
306/3	25	30 x 60	1490.00
306/4	60	40 x 80	3090.00
306/5*	20	50 x 25	2790.00
306/6*	40	60 x 30	3590.00

\* SQUAT SHAPE

**307. ALL PTFE SCREW CAP BOTTLES WIDE MOUTH**

Cat No.	Cap. ml.	Price
307/1	25	1690.00
307/2	50	1890.00
307/3	125	3890.00
307/4	250	6990.00
307/5	500	9990.00
307/6	1000	15590.00

**308. TEFLON / P.T.F.E COATED OVAL/EGG/OCTAGON MAGNETIC ROTORS**

Cat No.	Length	Dia	Price
308/1	8	4	400.00
308/2	10	5	470.00
308/3	15	6	550.00
308/4	20	10	610.00
308/5	25	12	650.00
308/6	30	16	980.00
308/7	35	16	1200.00
308/8	40	20	1250.00
308/9	50	20	1600.00

88





**309. PTFE BEAKERS HEAT RESISTANCE TO 260° C,  
INERT TO ALL MATERIALS EXCEPT MOLETEN  
ALKALI METALS**

Cat No	Cap. ml.	Price Beaker(B)	Price Lid (L)
309/1	10	195.00	76.00
309/2	25	270.00	136.00
309/3	50	445.00	196.00
309/4	100	895.00	296.00
309/5	250	1495.00	390.00
309/6	500	2395.00	496.00
309/7	1000	4195.00	596.00
309/8	2000	11495.00	1196.00

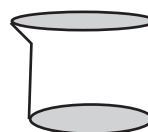

309

**310. PTFE COATED MAGNETIC STIRRING ROTORS  
NEEDLE BARS WITH CENTRE RING**

Cat No.	Length mm	Dia mm	Price
310/1	12	6	296.00
310/2	15	7	316.00
310/3	20	9	336.00
310/4	25	9	396.00
310/5	30	9	456.00
310/6	35	9	496.00
310/7	50	9	646.00
310/8	35	13	896.00
310/9	50	13	996.00



310

**311. PTFE POLICEMAN WITH MAGNETIC ROTOR**

311/1	Length 12"	1490.00
-------	------------	---------



311



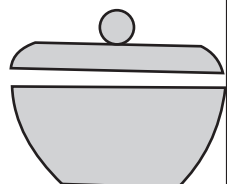

312

**312. PTFE CRUCIBLES WITH LID**

Cat No.	Cap. ml.	Price Crucible(c)	Price Lid (L)
312/1	15	400.00	444.00
312/2	25	550.00	690.00
312/3	50	950.00	1096.00
312/3	100	2000.00	1694.00

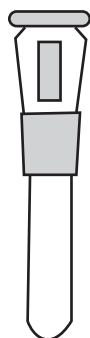

313

**313. PTFE THERMOMETER POCKET**

Cat No.	Cone	Price
313/1	B14	1090.00
313/2	B19	1396.00
313/3	B24	1390.00
313/4	B29	1890.00
313/5	B34	2094.00

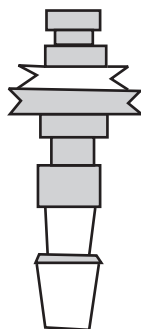

314

**314. ALL PTFE PULLEY WITH CONE WITHOUT BEARING WITH ROTATION ON BUSHES**

Cat No.	Cone	Price
314/1	B19	2990.00
314/2	B24	3196.00
314/3	B29	3794.00
314/4	B34	5590.00





**AMBER COLOUR GLASSWARE**

**315. AMBER COLOUR BURETTES WITH STRAIGHT BORE STOPCOCK, ACCURACY AS PER CLASS B**

Cat No.	Cap. ml.	Sub. Div. ml.	Tolerance ml.	Price
315/1	1	0.02	0.01	790.00
315/2	2	0.02	0.02	790.00
315/3	5	0.05	0.02	1390.00
315/4	10	0.05	0.05	1696.00
315/5	25	0.10	0.10	1696.00
315/6	50	0.10	0.10	2090.00
315/7	100	0.20	0.20	2490.00

**316. AMBER COLOUR BURETTES WITH STRAIGHT STOPCOCK, ACCURACY AS PER CLASS A WITH WORK CERTIFICATE**

Cat No.	Cap. ml.	Sub. Div. ml.	Tolerance ml.	Price
316/1	1	0.02	0.006	2990.00
316/2	2	0.02	0.010	2990.00
316/3	5	0.05	0.010	2990.00
316/4	10	0.05	0.020	3190.00
316/5	25	0.10	0.050	3190.00
316/6	50	0.10	0.050	3390.00
316/7	100	0.20	0.010	3990.00

**317. AMBER COLOUR BURETTES DOUBLE OBLIQUE BORE STOPCOCK 3 WAY ACCURACY AS PER CLASS B**

Cat No.	Cap. ml.	Sub. Div. ml.	Tolerance ml.	Price
317/1	1	0.02	0.01	3990.00
317/2	2	0.02	0.02	3990.00
317/3	5	0.02	0.02	4090.00
317/4	10	0.05	0.05	4090.00
317/5	25	0.10	0.10	4490.00
317/6	50	0.10	0.10	4590.00
317/7	100	0.20	0.10	4790.00

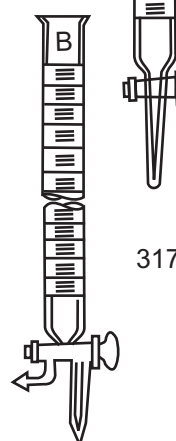
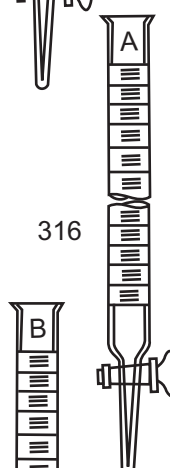



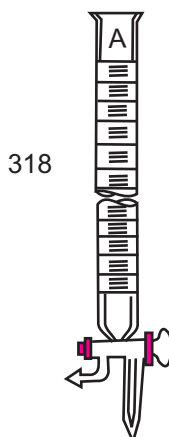

**318. AMBER COLOUR BURETTES DOUBLE OBLIQUE BORE STOPCOCK 3 WAY ACCURACY AS PER CLASS A WITH WORK CERTIFICATE**

Cat No.	Cap. ml.	Sub. Div. ml.	Tolerance ml.	Price
318/1	1	0.02	0.006	4990.00
318/2	2	0.02	0.010	4490.00
318/3	5	0.05	0.010	5190.00
318/4	10	0.05	0.020	5790.00
318/5	25	0.10	0.050	5990.00
318/6	50	0.10	0.050	6190.00
318/7	100	0.20	0.100	6390.00

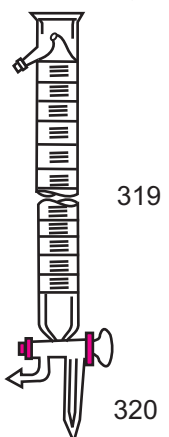

**319. AMBER COLOUR BURETTES DOUBLE OBLIQUE BORE STOPCOCK 3 WAY AUTOMATIC ZERO ACCURACY AS PER CLASS B**

Cat No.	Cap. ml.	Sub. Div. ml.	Tolerance ml.	Price
319/1	10	0.05	0.05	5590.00
319/2	25	0.10	0.01	5990.00
319/3	50	0.10	0.01	6190.00
319/4	100	0.20	0.20	6990.00

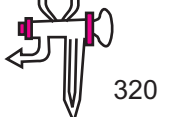

**320. AMBER COLOUR BURETTES DOUBLE OBLIQUE BORE STOPCOCK 3 WAY AUTOMATIC ZERO ACCURACY AS PER CLASS A WITH WORK CERTIFICATE**

Cat No.	Cap. ml.	Sub. Div. ml.	Tolerance ml.	Price
320/1	10	0.05	0.02	7590.00
320/2	25	0.10	0.05	7790.00
320/3	50	0.10	0.05	8190.00
320/4	100	0.20	0.10	8990.00





**321. AMBER COLOUR BURETTES AUTOMATIC ZERO MOUNTED ON RESERVIOR CLASS B COMPLETE WITH RUBBER PUMP**

Cat No.	Cap. ml.	Sub.Div.ml.	Tolerance ml.	Price
321/1	5	0.05	0.02	9990.00
321/2	10	0.05	0.05	9990.00
321/3	25	0.10	0.10	10590.00
321/4	50	0.10	0.10	10590.00
321/5	100	0.20	0.20	10590.00

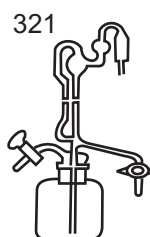

321

**322. AMBER COLOUR BURETTES AUTOMATIC ZERO MOUNTED ON RESERVIOR CLASS A WITH WORK CERTIFICATE COMPLETE WITH RUBBER PUMP**

Cat No.	Cap.ml.	Sub.Div.ml.	Tolerance ml.	Price
322/1	5	0.05	0.01	14990.00
322/2	10	0.05	0.02	14990.00
322/3	25	0.10	0.05	15390.00
322/4	50	0.10	0.05	15790.00
322/5	100	0.20	0.10	15990.00

322

**323. AMBER COLOUR CYLINDERS GRADUATED WITH SPOUT ACCURACY AS PER CLASS B**

Cat No.	Cap.ml.	Sub.Div.ml.	Tolerance ml.	Price
323/1	5	0.01	0.10	590.00
323/2	10	0.20	0.20	690.00
323/3	25	0.50	0.50	740.00
323/4	50	1.00	1.00	840.00
323/5	100	1.00	1.00	990.00
323/6	250	2.00	2.00	1490.00
323/7	500	5.00	5.00	2590.00
323/8	1000	10.0	10.0	3690.00
323/9	2000	20.0	20.0	4890.00

323



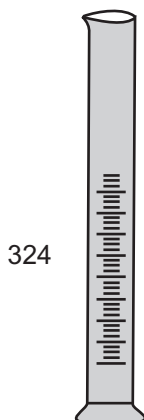

**324. AMBER COLOUR CYLINDER GRADUATED WITH POUR OUT AS ACCURACY AS PER CLASS A WITH WORK CERTIFICATE**

Cat No.	Cap. ml.	Sub. Div. ml.	Tolerance ml.	Price
324/1	5	0.1	0.05	1040.00
324/2	10	0.2	0.1	1090.00
324/3	25	0.5	0.25	1290.00
324/4	50	1.0	0.5	1540.00
324/5	100	1.0	1.0	1890.00
324/6	250	2.0	1.0	2390.00
324/7	500	5.0	2.5	3590.00
324/8	1000	10.0	5.0	4090.00
324/9	2000	20.0	10.0	5990.00

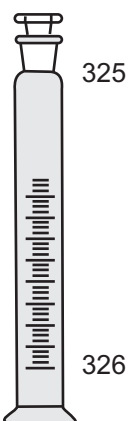

**325. AMBER COLOUR CYLINDERS GRADUATED WITH INTERCHANGEABLE STOPPER, ACCURACY AS PER CLASS B**

Cat No.	Cap. ml.	Sub. Div. ml.	Tolerance ml.	Stopper	Price
325/1	5	0.1	0.1	10/15	710.00
325/2	10	0.2	0.2	10/15	740.00
325/3	25	0.5	0.5	14/15	790.00
325/4	50	1.0	1.0	14/15	1090.00
325/5	100	1.0	1.0	19/20	1340.00
325/6	250	2.0	2.0	24/25	1990.00
325/7	500	5.0	5.0	24/25	3590.00
325/8	1000	10.0	10.0	34/35	4590.00
325/9	2000	20.0	20.0	34/35	6390.00

**326. AMBER COLOUR CYLINDER GRADUATED WITH INTERCHANGEABLE STOPPER, ACCURACY AS PER CLASS A**

Cat No.	Cap. ml.	Sub. Div. ml.	Tolerance ml.	Stopper	Price
326/1	5	0.1	0.25	10/15	1290.00
326/2	10	0.2	0.1	10/15	1390.00
326/3	25	0.5	0.25	14/15	1540.00
326/4	50	1.0	0.5	14/15	1690.00
326/5	100	1.0	1.0	19/20	2090.00
326/6	250	2.0	1.0	24/25	3090.00
326/7	500	5.0	2.5	24/25	4390.00
326/8	1000	10.0	5.0	34/35	5890.00
326/9	2000	20.0	20.0	34/35	9590.00





**327. AMBER COLOUR FLASK VOLUMETRIC WITH INTERCHANGEABLE STOPPER ACCURACY AS PER CLASS B**

Cat No.	Cap. ml.	Tolerance ml.	Price
327/1	1	0.02	490.00
327/2	5	0.05	490.00
327/3	10	0.05	510.00
327/4	25	0.08	570.00
327/5	50	0.12	630.00
327/6	100	0.20	730.00
327/7	200	0.30	1010.00
327/8	250	0.30	1050.00
327/9	500	0.50	1290.00
327/10	1000	0.80	1590.00
327/11	2000	1.20	3190.00



**328. AMBER COLOUR FLASK VOLUMETRIC WITH INTERCHANGEABLE STOPPER. ACCURACY AS PER CLASS A WITH WORK CERTIFICATE**

Cat No.	Cap. ml.	Tolerance ml.	Price
328/1	1	0.010	1440.00
328/2	5	0.025	1440.00
328/3	10	0.025	1390.00
328/4	25	0.040	1390.00
328/5	50	0.060	1590.00
328/6	100	0.100	1590.00
328/7	200	0.150	1690.00
328/8	250	0.150	1750.00
328/9	500	0.250	2890.00
328/10	1000	0.400	2990.00
328/11	2000	0.500	4090.00





329

330

331

**329. AMBER COLOUR PIPETTE TRANSFER VOLUMETRIC ACCURACY AS PER CLASS B**

Cat No.	Cap. ml.	Tolerance ml.	Price
329/1	1	0.015	350.00
329/2	2	0.020	350.00
329/3	5	0.030	400.00
329/4	10	0.040	450.00
329/5	20	0.060	540.00
329/6	25	0.060	540.00
329/7	50	0.100	590.00
329/8	100	0.160	690.00

**330. AMBER COLOUR PIPETTE TRANSFER VOLUMETRIC ACCURACY AS PER CLASS A**

Cat No.	Cap. ml.	Tolerance ml.	Price
330/1	1	0.007	650.00
330/2	2	0.010	650.00
330/3	5	0.015	650.00
330/4	10	0.020	730.00
330/5	20	0.030	850.00
330/6	25	0.030	950.00
330/7	50	0.050	1040.00
330/8	100	0.080	1280.00

**331. AMBER COLOUR PIPETTE SEROLOGICAL (GRADUATED PIPETTE) ACCURACY AS PER CLASS B**

Cat No.	Cap. ml.	Sub. Div.	Tolerance ml.	Price
331/1	0.1	0.01	0.01	390.00
331/2	0.2	0.01	0.01	390.00
331/3	0.5	0.01	0.01	390.00
331/4	1.0	0.10	0.01	410.00
331/5	1.0	0.01	0.01	410.00
331/6	2.0	0.10	0.02	440.00
331/7	2.0	0.02	0.02	440.00
331/8	5.0	0.05	0.05	490.00
331/9	5.0	0.05	0.10	490.00
331/10	10.0	0.10	0.10	540.00
331/11	25.0	0.20	0.20	590.00





**332. AMBER COLOUR PIPETTE SEROLOGICAL  
(GRADUATED PIPETTE) ACCURACY AS PER CLASS A  
WITH WORK CERTIFICATE**

Cat No.	Cap. ml.	Sub. Div.	Tolerance ml.	Price
332/1	0.1	0.10	0.006	746.00
332/2	0.2	0.10	0.006	746.00
332/3	0.5	0.02	0.006	796.00
332/4	1.0	0.10	0.006	796.00
332/5	1.0	0.01	0.006	796.00
332/6	2.0	0.02	0.010	844.00
332/7	2.0	0.10	0.010	888.00
332/8	5.0	0.10	0.030	896.00
332/9	5.0	0.05	0.030	896.00
332/10	10.0	0.10	0.050	946.00
332/11	25.0	0.20	0.100	1096.00



332

**333. AMBER COLOUR SEPARATING FUNNEL WITH GLASS  
STOPCOCK AND INTERCHANGEABLE STOPPER  
PEAR SHAPE OR GLOBAL SHAPE**

Cat No.	Cap. ml.	Price
333/1	25	1096.00
333/2	60	1390.00
333/3	125	1790.00
333/4	250	2090.00
333/5	500	2390.00
333/6	1000	3090.00
333/7	2000	4990.00
333/8	3000	8990.00
333/9	5000	11990.00



333

**334. AMBER COLOUR PETRI DISH CULTURE**

Cat No.	Dia x Ht. mm	Price
334/1	50 x 17	696.00
334/2	80 x 17	990.00
334/3	100 x 17	1096.00
334/4	150 x 17	1496.00
334/5	200 x 17	2990.00



334





335

**335. AMBER COLOUR REAGENT BOTTLES N.M. WITH INTERCHANGEABLE STOPPER**

Cat No.	Cap. ml.	Price
335/1	30	696.00
335/2	60	746.00
335/3	125	790.00
335/4	250	896.00
335/5	500	990.00
335/6	1000	1390.00
335/7	2000	2096.00



336

**336. AMBER COLOUR REAGENT BOTTLES WIDE MOUTH WITH INTERCHANGEABLE STOPPER**

Cat No.	Cap. ml.	Price
336/1	30	696.00
336/2	60	744.00
336/3	125	896.00
336/4	250	1096.00



337

**337. CONICAL N.M. WITH INTERCHANGEABLE STOPPER**

Cat No.	Cap. ml.	Price
337/1	50	596.00
337/2	100	644.00
337/3	150	796.00
337/4	250	890.00
337/5	500	1044.00
337/6	1000	1396.00





**338. AMBER COLOUR FLASK R.B. OR F.B.**

Cat No.	Cap ml.	Socket	Price
338/1	100	19/26	496.00
338/2	250	24/29	696.00
338/3	500	24/29	790.00
338/4	1000	24/29	1296.00



338

**339. AMBER COLOUR DROPPING BOTTLE COMPLETE WITH GROUND IN PIPETTE & RUBBER TEAT**

Cat No.	Cap. ml.	Price
339/1	30	744.00
339/2	60	844.00
339/3	125	990.00



339

**340. AMBER COLOUR BOTTLES ASPIRATOR WITH INTERCHANGEABLE STOPPER AND STOPCOCK**

Cat No.	Cap. ml	Price
340/1	1000	5990.00
340/2	2000	6990.00
340/3	5000	22390.00
340/4	10000	29990.00



340







**PIPELINE COMPONENTS**

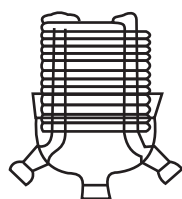

341

**341. IMMERSION HEAT EXCHANGER**

Cat No.	Ref/Dia	Price
341/1	HEM 4	16195.00
341/2	HEM 6	26495.00
341/3	HEM 9	48995.00

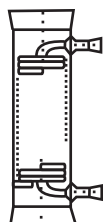

342

**342. HEAT EXCHANGER CONDENSER TYPE**

Cat No.	Ref/Dia	Length mm	Price
342/1	HE 1.5	600	5295.00
342/2	HE 2	610	7895.00
342/3	HE 3	610	10095.00
342/4	HE 4	610	16195.00
342/5	HE 6	840	30795.00
342/6	HE 9	790	64495.00

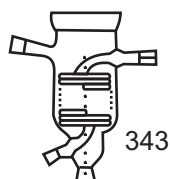

343

**343. HEAT EXCHANGER BOILER TYPE**

Cat No.	Ref/Dia	Price
343/1	HEB 4	16195.00
343/2	HEB 6	38495.00
343/3	HEB 9	50995.00

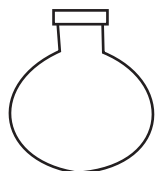

344

**344. SPHERICAL VESSELS (SINGLE NECK)**

Cat No.	Ref/Dia	Neck Size	Price
344/1	VSA 5	40	5295.00
344/2	VSA 10	40	10295.00
344/3	VSA 20	80	18990.00
344/4	VSA 50	100	50495.00
344/5	VSA 100	150	103990.00
344/6	VSA 200	225	191990.00



345

**345. VESSEL TWO NECKS WITH BOTTOM OUTLET**

Cat No.	Ref/Dia	Price
345/1	VSF 5	6190.00
345/2	VSF 10	12390.00
345/3	VSF 20	22990.00
345/4	VSF 50	64990.00

100





### 346. VESSEL THREE NECK WITH BOTTOM OUTLET

Cat No.	Ref/Dia	Price
346/1	VSM 5	6190.00
346/2	VSM 10	11590.00
346/3	VSM 20	21990.00
346/4	VSM 50	65990.00



346

### 347. VESSEL FOUR NECK WITH BOTTOM OUTLET

Cat No.	Ref/Dia	Price
347/1	VSPL 20	23990.00
347/2	VSPL 50	69990.00
347/3	VSPL 100	133990.00
347/4	VSPL 200	239990.00

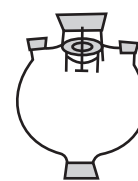

347

### 348. REACTION VESSEL CYLINDRICAL

Cat No.	Ref/Dia	Price
348/1	VZ 5/C	9590.00
348/2	VZ 10/6	12990.00
348/3	VZ 20/9	31790.00
348/4	VZ 30/12	65990.00
348/5	VZ 50/12	75990.00



348

### 349. HEAT EXCHANGER (SHELL & TUBE) HIGHLY SUITABLE WHERE LARGE HEAT TRANSFER AREAS ARE REQUIRED IN RELATIVELY CONFINED SPACES

Cat No.	Ref/Dia	Price
349/1	RGG 6/3 Glass Shell	225995.00
349/2	RGG 6/4 Glass Shell	241995.00
349/3	RGG 6/6 Glass Shell	277995.00
349/4	RGG 9/6 Glass Shell	289995.00
349/5	RGG 9/12 Glass Shell	389995.00
349/6	RGG 12/12 Glass Shell	489995.00
349/7	RGG 12/21 Glass Shell	689995.00
349/8	RMG 6/3 MS Shell	160995.00
349/9	RMG 6/4 MS Shell	180995.00
349/10	RMG 6/6 MS Shell	185995.00
349/11	RMG 9/6 MS Shell	195995.00
349/12	RMG 9/12 MS Shell	255995.00
349/13	RMG 12/12 MS Shell	355995.00
349/14	RMG 12/21 MS Shell	344995.00

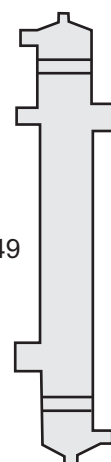

349

101





350

**350. PIPE SECTION OR COLUMN SECTION**

Cat No.	Ref/Dia	x	Length mm	Price
350/1	PS		1/150	1090.00
350/2	PS		1/300	1290.00
350/3	PS		1/600	1890.00
350/4	PS		1/1000	2390.00
350/5	PS		1/1200	2790.00
350/6	PS		1.5/150	1290.00
350/7	PS		1.5/300	1890.00
350/8	PS		1.5/600	2590.00
350/9	PS		1.5/1000	3990.00
350/10	PS		1.5/1200	3990.00
350/11	PS		2/150	1990.00
350/12	PS		2/300	3190.00
350/13	PS		2/600	3790.00
350/14	PS		2/1000	5990.00
350/15	PS		3/300	4390.00
350/16	PS		3/600	6990.00
350/17	PS		3/1000	8990.00
350/18	PS		3/1500	15790.00
350/19	PS		4/300	7590.00
350/20	PS		4/600	11590.00
350/21	PS		4/1000	17590.00
350/22	PS		4/1500	22990.00
350/23	PS		6/1000	22990.00
350/24	PS		6/1500	34990.00
350/25	PS		9/1000	43990.00
350/26	PS		9/1500	59990.00
350/27	PS		12/1000	89990.00
350/28	PS		12/1500	135990.00

**351. PACKING SUPPORT PERFORATED PLATE OR HONEY COMB JALI**

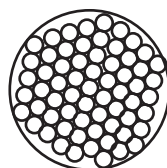

351

Cat No.	Ref/Dia	Price
351/1	CP 2	645.00
351/2	CP 3	945.00
351/3	CP 4	945.00
351/4	CP 6	1295.00
351/5	CP 9	1895.00
351/6	CP 12	5295.00





**352. RASHING RINGS (NEUTRAL GLASS)**

Cat No.	Ref/Dia	Price/Kg.
352/1	FC 9	895.00
352/2	FC 12	1100.00
352/3	FC 15	1100.00
352/4	FC 25	1990.00



352

**353. REFLUX SEPARATOR MANUALLY OPERATED**

Cat No.	Ref/Dia	Price
353/1	RDA 3	5995.00
353/2	RDA 4	6795.00
353/3	RDA 6	21595.00
353/4	RDA 9	31995.00
353/5	RDA 12	63995.00

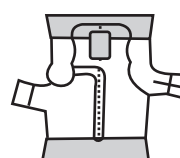

353

**354. REFLUX SEPARATOR MAGNETIC**

Cat No.	Ref/Dia	Price
354/1	RHM 3	9995.00
354/2	RHM 4	16495.00
354/3	RHM 6	19995.00
354/4	RHM 9	33495.00
354/5	RHM 12	70995.00

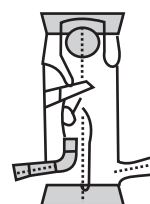

354

**ELECTRO MAGNET & TIMERS MACHINE EXTRA CHARGES**

**355. COLUMN FEED PIPES**

Cat No.	Ref/Dia	Price
355/1	FP 3	995.00
355/2	FP 4	1045.00
355/3	FP 6	1095.00



355

**356. COLUMNS ADAPTERS**

Cat No.	Ref/Dia	Price
356/1	CA 2/1/1	1695.00
356/2	CA 3/1.5/1	1995.00
356/3	CA 4/1/1	3095.00
356/4	CA 4/1.5/1	3295.00
356/5	CA 4/2/1	3595.00
356/6	CA 6/1.5/1.5	4895.00
356/7	CA 6/2/1	5095.00
356/8	CA 6/3/1	6095.00

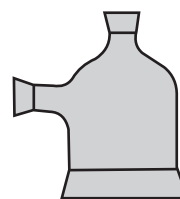

356



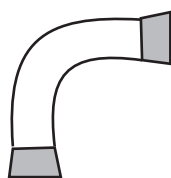

357

**357. PIPE BENDS 45--90--100 ANY SIZE ANGLE**

Cat No.	Ref/Dia	Price
357/1	PB 1	1090.00
357/2	PB 1.5	1990.00
357/3	PB 2	2390.00
357/4	PB 3	8990.00
357/5	PB 4	1390.00
357/6	PB 6	24495.00
357/7	PB 9	52995.00
357/8	PB 12	70995.00

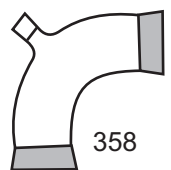

358

**358. PIPE BENDS 90° WITH THERMOMETER POCKET**

Cat No.	Ref/Dia	Price
358/1	PBT 1.5/1	2695.00
358/2	PBT 2/1	3295.00
358/3	PBT 3/1	8895.00
358/4	PBT 4/1	11685.00
358/5	PBT 6/1	26995.00
358/6	PBT 9/1	58995.00

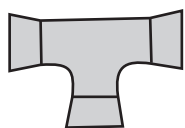

359

**360. EQUAL T PIECES**

Cat No.	Ref/Dia	Price
359/1	PT 1	1645.00
359/2	PT 1.5	1845.00
359/3	PT 2	4495.00
359/4	PT 3	12895.00
359/5	PT 4	18495.00
359/6	PT 6	34995.00
359/7	PT 9	68995.00
359/8	PT 12	138995.00





**360. UNEQUAL T PIECES**

Cat No.	Ref/Dia	Price
360/1	PTU 1.5/1	1495.00
360/2	PTU 2/1	2695.00
360/3	PTU 2/1.5	4895.00
360/4	PTU 3/1	5095.00
360/5	PTU 3/1.5	5495.00
360/6	PTU 3/2	6695.00
360/7	PTU 4/1.5	7695.00
360/8	PTU 4/2	8895.00
360/9	PTU 4/3	10895.00
360/10	PTU 6/1.5	12095.00
360/11	PTU 6/2	12595.00
360/12	PTU 6/3	12995.00
360/13	PTU 6/4	14195.00
360/14	PTU 9/2	28495.00
360/15	PTU 9/4	42795.00
360/16	PTU 12/4	72995.00
360/17	PTU 12/6	86995.00

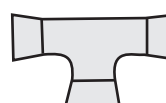

**360**

**361. 'Y' PIECES**

Cat No.	Ref/Dia	Price
361/1	PY 1	1495.00
361/2	PY 1.5	2695.00
361/3	PY 2	4895.00
361/4	PY 3	8895.00
361/5	PY 4	17895.00



**361**

**362. EQUAL CROSS**

Cat No.	Ref/Dia	Price
362/1	PX 1	1690.00
362/2	PX 1.5	3295.00
362/3	PX 2	5295.00
362/4	PX 3	11495.00
362/5	PX 4	22495.00

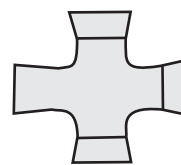

**362**

**363. 'U' BENDS**

Cat No.	Ref/Dia	Price
363/1	PU 1	1895.00
363/2	PU 1.5	2895.00
363/3	PU 2	4895.00
363/4	PU 3	10695.00



**363**





364

**364. 'U' BENDS WITH BOTTOM OUTLET**

Cat No.	Ref/Dia	Price
364/1	PUO 1	2445.00
364/2	PUO 1.5	3695.00
364/3	PUO 2	5495.00
364/4	PUO 3	10895.00

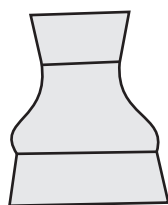

365

**365. PIPE REDUCERS**

Cat No.	Ref/Dia	Price
365/1	PR 1/07	645.00
365/2	PR 1.5/1	895.00
365/3	PR 2/1	1095.00
365/4	PR 2/1.5	1495.00
365/5	PR 3/1	2895.00
365/6	PR 3/1.5	2895.00
365/7	PR 3/2	2895.00
365/8	PR 4/1	4695.00
365/9	PR 4/1.5	4695.00
365/10	PR 4/2	5295.00
365/11	PR 4/3	5295.00
365/12	PR 6/1.5	7295.00
365/13	PR 6/2	7695.00
365/14	PR 6/3	7895.00
365/15	PR 6/4	8895.00
365/16	PR 9/4	14295.00
365/17	PR 9/6	14695.00
365/18	PR 12/4	34495.00
365/19	PR 12/6	38495.00

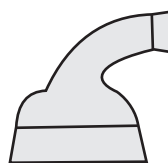

366

**366. PIPE BENDS REDUCERS 90°**

Cat No.	Ref/Dia	Price
366/1	PBR 1.5/1	1095.00
366/2	PBR 2/1	1495.00
366/3	PBR 2/1.5	1895.00
366/4	PBR 3/1	2695.00
366/5	PBR 3/1.5	2895.00
366/6	PBR 3/2	2895.00
366/7	PBR 4/1	4495.00
366/8	PBR 4/2	4495.00
366/9	PBR 4/3	5295.00
366/10	PBR 6/4	10895.00





**367. PIPE REDUCER WITH GROUND GLASS CONICAL JOINT**

Cat No.	Ref/Dia	Price
367/1	PR 1/B 24S	895.00
367/2	PR 1.5B 24S	1095.00
367/3	PR 2/B 24S	1295.00
367/4	PR 3/B 34S	2895.00
367/5	PR 4/B 34S	3895.00
367/6	PR 4/B 55S	3895.00



367

**368. HOSE CONNECTION**

Cat No.	Ref/Dia	Price
368/1	PHC 1/07	695.00
368/2	PHC 1	695.00
368/3	PHC 1.5/07	895.00
368/4	PHC 1.5/1	895.00
368/5	PHC 1.5	1095.00
368/6	PHC 2/1	1295.00



368

**369. PIPE CLOSURES (STOPPERS)**

Cat No.	Ref/Dia	Price
369/1	PBE 07	495.00
369/2	PBE 1	620.00
369/3	PBE 1.5	645.00
369/4	PBE 2	845.00
369/5	PBE 3	1895.00
369/6	PBE 4	3895.00
369/7	PBE 6	5895.00



369

**370. THERMOMETER POCKETS**

Cat No.	Ref/Dia	Price
370/1	TP 20/1	895.00
370/2	TP 50/1.5	1095.00
370/3	TP 100/1.5	1445.00
370/4	TP 200/1.5	1695.00



370





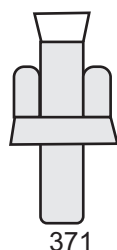

371

**371. DIP PIPE ADAPTERS SHORT**

Cat No.	Ref/Dia	Price
371/1	DP 1/07	895.00
371/2	DP 1/1	1295.00
371/3	DP 1.5/1	1645.00
371/4	DP 1.5/1.5	1695.00
371/5	DP 2/1	1895.00
371/6	DP 2/1.5	2295.00
371/7	DP 3/1.5	3895.00
371/8	DP 4/1.5	6895.00

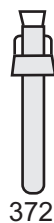

372

**372. DIP PIPE ADAPTERS LONG**

Cat No.	Ref/Dia	Price
372/1	DP 20/1	1245.00
372/2	DP 50/1	1245.00
372/3	DP 50/1.5	1895.00
372/4	DP 100/1.5	2245.00
372/5	DP 200/1.5	2295.00

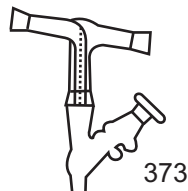

373

**373. LIQUID SEALS**

Cat No.	Ref/Dia	Price
373/1	LSV 1	2895.00
373/2	LSV 1.5	3495.00

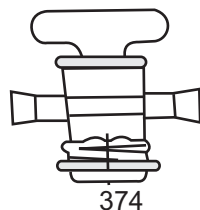

374

**374. LINE STOPCOCK**

Cat No.	Ref/Dia	Price
374/1	TS 1/07/1	6895.00
374/2	TS 1.5/1/1.5	9495.00
374/3	TS 2/1.5/2	12895.00

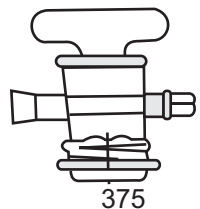

375

**375. DRAIN STOPCOCK**

Cat No.	Ref/Dia	Price
375/1	TD 1/07	5895.00
375/2	TD 1	7495.00
375/3	TD 1.5/1	9495.00





376. STOPCOCKT BORE		
Cat No.	Ref/Dia	Price
376/1	TST 1/07	8895.00
376/2	TST 1	10895.00
376/3	TST 1.5/1	12895.00

377. VACUUM STOPCOCK		
Cat No.	Ref/Dia	Price
377/1	VST 1/.25	5895.00
377/2	VST 1.5/.25	6895.00
377/3	VST 2/.25	1095.00

378. SCREWDOWN STRAIGHT THROUGH VALVES		
Cat No.	Ref/Dia	Price
378/1	PV 1/07	7095.00
378/2	PV 1	7895.00
378/3	PV 1.5/1	9895.00
378/4	PV 1.5	10295.00
378/5	PV 2/1.5	17795.00
378/6	PV 2	18195.00

  

379. SCREWDOWN DRAIN VALVES		
Cat No.	Ref/Dia	Price
379/1	PVD 1	7295.00
379/2	PVD 1.5/1	8895.00
379/3	PVD 1.5	10295.00
379/4	PVD 2/1.5	16195.00
379/5	PVD 2	18495.00

380. PTFE ENVELOPE GASKET		
Cat No.	Ref/Dia	Price
380/1	TM 1	225.00
380/2	TM 1.5	245.00
380/3	TM 2	260.00
380/4	TM 3	290.00
380/5	TM 4	245.00
380/6	TM 6	645.00



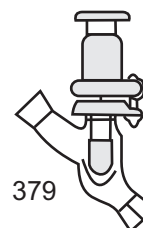
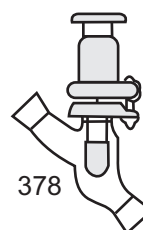
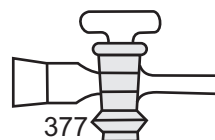
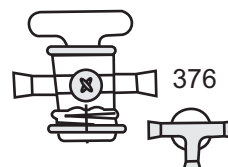

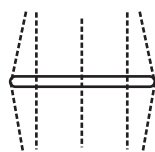
381

**381. PTFE 'O' RING / CRESCENT RINGS**

Cat No.	Ref/Dia	Price
381/1	TR 1	240.00
381/2	TR 1.5	265.00
381/3	TR 2	275.00
381/4	TR 3	430.00
381/5	TR 4	645.00
381/6	TR 6	870.00

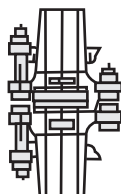

382

**382. PTFE BELLOWS FOR CONNECTING GLASS TO GLASS**

Cat No.	Ref/Dia	Price
382/1	FBN 1	2495.00
382/2	FBN 1.5	3095.00
382/3	FBN 2	3495.00
382/4	FBN 3	5895.00
382/5	FBN 4	8695.00
382/6	FBN 6	13895.00



383

**383. BACKING FLANGES IN PAIR WITH INSERT AND NUT BOLTS**

Cat No.	Ref/Dia	Price
383/1	CT 07	485.00
383/2	CT 1	845.00
383/3	CT 1.5	895.00
383/4	CT 2	1090.00
383/5	CT 3	1590.00
383/6	CT 4	2095.00
383/7	CT 6	2845.00





### FUSED SILICA QUARTZ GLASSWARE

In all Research and Development Institutions and modern Industries, it is all the same in any Laboratory, a certain range of Silica is required. **BENGAL** offers with its range a wide palette of products of Silica Glass which are required by any user. Silica is being described as quartz, quartz glass, fused quartz silica, fused silica etc. The High degree of ambiguity of the terms used for describing this material can be avoided by simply calling it "Silica Glass or Vitrous Silica" transparent or translucent which is sio<sub>2</sub> in glass form. The use of single word quartz is absolutely in correct as it refers to common crystalline form of silica found in nature.

There are only handful number of basic silica glass manufacturers in the world market, the reason being the complexity of manufacturing process of silica glass which demands sophisticated technology and availability of raw material of high purity. Since last five year our policy has been to offer best available material to our customers, therefore we insist on using best material in the market for fabrication of our silica glass items.

According to requirement we are able to offer the most suited kind of apparatus as we are in a position, both to fabricate an wide range of products due to our new technologies and to meet the wished of our customers for a good quality and large quantity.

#### TECHNICAL DETAILS:

Silica Glass i.e. silicium oxide (SiO<sub>2</sub>) is found on the earth in the form of quartz crystals or quartz sand. This material is converted into silica glass either transparent or translucent (opaque) depending on the raw material used and the process adopted for manufacturing. Translucent silica glass is made by melting very pure quartz sand. It's capacity is due to the presence of minute trapped air bubbles. Transparent silica is made by melting rock crystal under vacuum. This process eliminates entrapment of air bubbles in the melt. The other method of manufacturing optical quality silica transparent glass is by synthesis process.

Silica Glass, Transparent or Translucent possesses a unique range of properties. No other material has such a combination of perfectly blended characteristics.

#### CORROSION RESISTANT:

Transparent silica glass is more resistant to chemical attack than the non-transparent form, this is because the effect of bubbles in the latter provides a great surface area to etchant. At room temperature all forms can be considered to be completely unaffected by all acids except hydrofluoric. At high temperature slight corrosion occurs with aqueous solutions of High PH and also with phosphoric acid but the degree of corrosion does not preclude the use of silica with those reagents. Salts and basic oxides reacts at elevated temperatures particularly above their melting point. The extent of the reaction is largely determined by the thermal diffusion of impurities into silica of which ions of the alkalis metal have highest diffusivity.

#### CHEMICAL PURITIES:

Silica glass has impurity contents less than 1000 pm (0.1%wt) but transparent silica glass is more pure as its impurity is even lower than 100 pm (0.01%wt)



**LOW EXPANSION:**

Silica Glass remains insensitive to sudden variations of temperature. Rise of temperature causes no change of shape and of dimension.

**DIVERSIFICATION:**

Silica glass can be safely used upto 1000°C. Its behaviour above this temperature depends on various parameters. Prolonged heating above 1000°C leads to conversion from metastable phase of silica to stable crystalline phase. This transformation or recrystallisation is known as diversification and it occurs mainly at surface and less frequently at internal defects. Diversification is favoured by impurities above 1000°C on continuous use but is lower when the material is more pure and clean. Alkalies and particularly phosphores, borates and components of the alkaline earth metals promote Diversification. This points should be remembered when silica glass is being used at high temperature reactor vessels or as refractory material in high temperature furnaces.

**GASEOUS AND IONIC DIFFUSION:**

The structure of silica glass is fairly open and at high temperature this allows the diffusion of some gases and ions through the network. Sodium has the highest mobility.

**EXCELLENT ELECTRICAL INSULATION:**

The principal electrical advantage of silica glass are high dielectrical field strength, low electric conductivity and low die-electrical losses even at high temperature. Transparent Silica Glass is highly recommended for high frequency at high voltage insulators especially when the parties are exposed to high temperature and powerful mechanical stresses.

**NUCLEAR APPLICATION:**

Silica glass with stand Nuclear radiation very well particularly neutron and gamma rays Contrary to most other material and is now frequently employed in nuclear experiments in reactor and glove box chamber.

**OPTICAL CHARACTERISTICS:**

In contrary to ordinary type of silicate glass transparent silica glass is distinguished by the exceptionally good optical transmission in all wavelengths. In IR (infra red) range apart from some special IR type of Glass, transmission and spectral transmission range area greater than with ordinary glass. Invisible range, transparent silica glass is more transparent. It is far better than all other glass in transmission. In UV (ultra violet) range and particularly in the short wave UV Range the optical characteristics of transparent silica Glass are very dependent on its chemical purity generally it is transparent to ultra range upto 200mm (2000A).

**MECHANICAL STRENGTH:**

For designing hollow ware in silica glass the strength quoted by manufacture are of the order 35kg/cm<sup>2</sup> and for plates and thin discs these figures are 48 kg/cm<sup>2</sup> and 78kg/cm<sup>2</sup> respectively.

**THERMAL PROPERTIES:**

Maximum working temperature continuous	1100°C
Maximum working temperature short term	1300°C
Softening Point	1600°C
Annealing Point	1120°C





**384. BEAKERS WITH SPOUT TRANSPARENT QUARTZ SQUAT FORM**

Cat No.	Cap.ml.	Dia mm	Height mm.	Price
384/1	10	23	35	470.00
384/2	25	30	60	845.00
384/3	50	40	60	1495.00
384/4	100	50	70	2645.00
384/5	150	55	80	3095.00
384/6	250	65	95	5295.00
384/7	500	80	110	9495.00
384/8	1000	100	145	16895.00



384

**385. BOAT COMBUSTION WITH HANDLE OR WITHOUT HANDLE TRANSLUCENT OR TRANSPARENT QUARTZ GLASS**

Cat No.	Length mm.	Width mm.	Height mm.	Price
385/1	50	12	8	295.00
385/2	76	11	7	420.00
385/3	77	14	9	445.00
385/4	77	12	8	295.00
385/5	78	17.5	11.5	495.00
385/6	78	20.5	12.5	620.00
385/7	103	20	12	695.00
385/8	125	25	15	1445.00
385/9	150	35	25	3895.00
385/10	150	45	35	3695.00



385

ALL DIMENSIONS ARE APPROXIMATE

**386. SILICA BASINS TRANSLUCENT WITH SPOUT**

Cat No.	OD mm	Price
386/1	22-25	225.00
386/2	48-52	245.00
386/3	55-60	285.00
386/4	70-75	620.00
386/5	80-85	870.00
386/6	90-95	1045.00
386/7	98-103	1470.00
386/8	110	1845.00



386



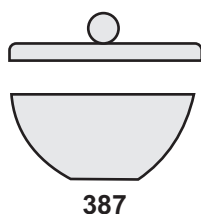

**387**

**387. SILICA CRUCIBLE WITH LID TRANSLUCENT**

Cat No.	Cap ml.	Price Crucible (C)	Price Lid (L)
387/1	15	260.00	280.00
387/2	25	300.00	315.00
387/3	50	550.00	450.00
387/4	80	750.00	790.00
387/5	100	980.00	990.00
387/6	150	1200.00	1190.00
387/7	250	1800.00	1990.00
387/8	15 Tall	350.00	250.00
387/9	30 Tall	450.00	290.00
387/10	50 Tall	650.00	390.00

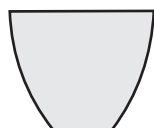

**388**

**388. SILICA CRUCIBLE TRANSPARENT FOR HIGHER TEMPERATURE**

Cat No.	Cap.ml.	Price Crucible (C)	Price Lid (L)
388/1	5 Squat	400.00	340.00
388/2	10 Squat	450.00	390.00
388/3	15 Squat	530.00	490.00
388/4	25 Squat	750.00	890.00
388/5	50 Squat	1100.00	1790.00
388/6	15 Tall	450.00	590.00
388/7	30 Tall	530.00	890.00
388/8	50 Tall	1050.00	1440.00
388/9	80 Tall	1450.00	2490.00

(YOU CAN OBSERVE THE REACTION IN TRANSPARENT CRUCIBLE WHILE HEATING)

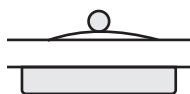

**389**

**389. CAPSULE CIRCULAR WITH GROUND LID MOISTURE AND ASH DETERMINATION SILICA**

Cat No.	Length mm	Dia mm	Price
389/1	11	38	790.00
389/2	12	54	990.00





**390. CIRCULAR CAPSULE FOR AIR AND MOISTURE DETERMINATION ON 1 OR 2 GM SAMPLE SILICA**

Cat No.	Height mm	Dia mm.	Cap ml.	Price
390/1	15	40	10	650.00
390/2	15	48	20	700.00
390/3	15	54	25	730.00
390/4	28	56	45	1190.00

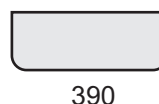

**391. COOKING CRUCIBLE WITH LID AND PROJECTION VOLATILE MATTER DETERMINATION SILICA TRANSLUCENT OR TRANSPARENT**

Cat No.	Item	Dia x Height mm	Price
391/1	Crucible	25 x 38	700.00
391/2	Plunger		540.00
391/3	Lid		430.00



**392. CRUCIBLE OF AGGLUTINATING VALUE OF LOCAL TRANSLUCENT**

Cat No.	OD x Ht mm	Price
392/1	42 x 42	990.00

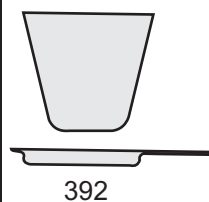

**393. QUARTZ GLASS DISTILLER MONO**  
 Distiller horizontal shape with silica sheathed heater, horizontal type boiler, high efficiency condenser output 1.2 litre per hour complete set made in transparent quartz glass  
 with Work manual 75990.00  
 Control unit for above 14000.00

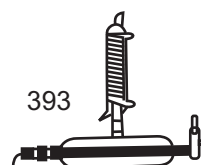

**394. QUARTZ GLASS DISTILLER MONO**  
 Distiller as above but only the high efficiency condenser is made or borosilicate glass and boiler of transparent quartz glass complete set working manual as above  
 with Work manual 43990.00  
 Control unit for above 14000.00





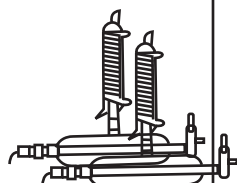

395

**395. QUARTZ GLASS DOUBLE DISTILLER**  
 Distiller with two stage boiler and multi cooling system complete set made of transparent quartz glass with Control unit

67995.00  
7995.00

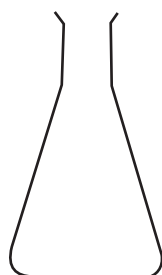

396

**396. FLASK CONICAL NARROW MOUTH TRANSPARENT SILICA**

Cat No.	Cap. ml.	Price Plain (P)	Price Socket (S)
396/1	10	700.00	1390.00
396/2	25	850.00	1890.00
396/3	50	1500.00	2790.00
396/3	100	1900.00	4390.00
396/4	150	2300.00	4590.00
396/5	250	6500.00	13790.00

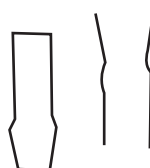

397

**397. GROUND JOINT CONICAL INTERCHANGEABLE SUITABLE FOR VACUUM TRANSPARENT SILICA GLASS ALSO**

Cat No.	Joint Size	Price/Pair
397/1	B - 7	840.00
397/2	B - 10	940.00
397/3	B - 14	1140.00
397/4	B - 19	1690.00
397/5	B - 24	2490.00
397/6	B - 29	3490.00
397/7	B - 34	5190.00
397/8	B - 40	6690.00
397/9	B - 45	8190.00
397/10	B - 50	9990.00
397/11	B - 55	11790.00

**BIGGER SIZES ON REQUEST**





**398. PLATE TRANSPARENT SILICA GLASS OPTICALLY POLISHED**

Cat No.	Size mm	Thickness mm	Price
398/1	150 x 150	1.5	9095.00
398/2	150 x 150	2	11095.00
398/3	150 x 150	3	15095.00
398/4	150 x 150	5-6	19595.00

SUBJECT TO AVAILABILITY



398

**399. PLATE TRANSPARENT SILICA GLASS OPTICALLY POLISHED**

Cat No.	Size mm	Thickness mm	Price Square (S)	Price Round (R)
399/1	25	1.5	575.00	1190.00
399/2	25	2	600.00	1240.00
399/3	25	3	725.00	1490.00
399/4	25	5-6	925.00	1990.00

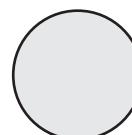

399

**400. STOPPER CLOSED ENDS TRANSPARENT SILICA GLASS**

Cat No.	Joint	Price
400/1	B-14	690.00
400/2	B-19	890.00
400/3	B-24	1390.00
400/4	B-29	1890.00
400/5	B-34	2790.00

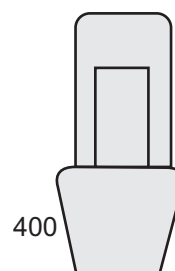

400

**401. SILICA TRIANGLE ON NICHROME WIRE**

Cat No.	Side Length mm	Price
401/1	38	250.00
401/2	50	350.00
401/3	63	400.00
401/4	75	500.00
401/5	100	550.00

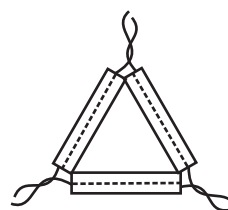

401





**HI-TECH GLASS APPARATUS**

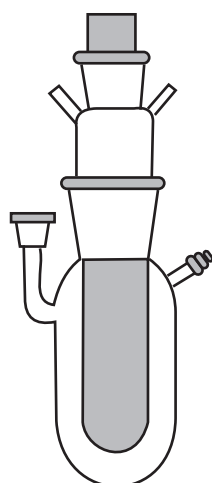

402

**402. PHOTO CHEMICAL QUARTZ GLASS REACTOR**

Cat. No.	Details	Price
402/1	Quartz Transport glass inner probe and outer jacket having B-60 cone with inlet and outlet tubes. The outer jacket is further fitted in borosilicate glass tube having B-60 socket.	109990.00
402/2	Photo Chemical glass reactor assembly with transparent silica glass probe of B-45, cone & outer glass jacket of borosilicate glass having B-45 cone with inlet and outlet tube. A cooling jacket of borosilicate glass with B-75 socket & inlet-outlet tube is also provided. Cap. 100 ml. or 200 ml.	37990.00
402/3	Photo chemical reactor assembly all borosilicate glass similar to 368/1	7495.00
402/4	Photo chemical reactor assembly having a transparent silica glass probe B-45 cone and outer jacket of borosilicate glass with B-45. socket fitted with inlet-outlet tube.	32495.00

**403. WATER STILL SINGLE**

- (a) Water still single stage horizontal mounted on a metallic base for distilled water resistivity in mega ohm range with auto mater level sensor for automatic cut off and audible alarm in case of water supply failure. All glass construction with silica sheathed heater, horizontal type boiler, high efficiency condenser, constant level device & control box with regulator and alarm.  
Distillate output 1.2 litres / hour with working manual

34495.00





**404. WATER STILLS SINGLE**

Price

(b) Water still single stage distillation horizontal mounted on a metallic base for distilled water resistivity in megal ohm range complete set same as above (Cat No. 369) but without control box

32000.00

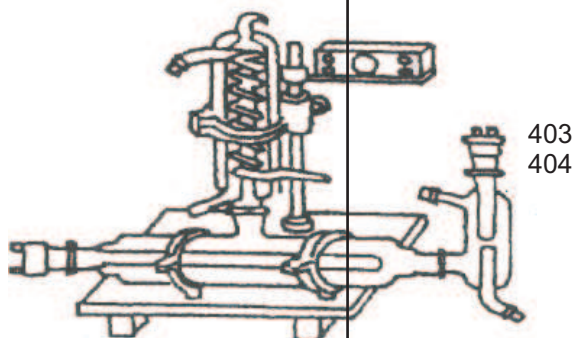

**405. WATER STILL DOUBLE**

Price

Water still double distillation horizontal mounted on a metallic base for distilled water resistivity in mega ohm range with auto water level sensor for automatic cut off and audible alarm in case of water supply failure. All glass construction with two horizontal boiler, high efficiency condensers constant level device and control box with regulator and alarm distillate output 1.2 litres / hour

63000.00

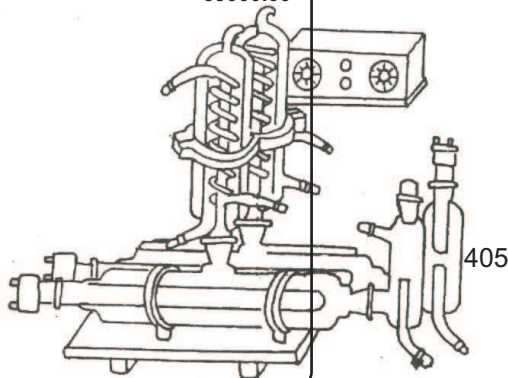



**406. WATER STILL DOUBLE**

Water still double distillation horizontal mounted on a metallic base for distilled water resistivity in megal ohm range complete set as above (Cat 371) but without control Box.

Price

34249.00

**SPARES:**

406/1	Horizontal Boiler	6000.00
406/2	High Efficiency Condenser	6800.00
406/3	Silica Sheathed Heater	9000.00
406/4	Constant level devices	1800.00

NOTE: \* Erection to be done at your end only.  
\* We do not guarantee life of Heater.

**407** Heating mantles are made of lid steel to accommodate several sizes of round bottom flasks and to provide uniform heating. Heating surface is made from fibre glass yarn, which has extra strength and longer life compared to asbestos surfaces. Bigger size of mantle have two or three heating circuit so that upper circuit could be switched off when lower part of flask is being heated or when liquid level drops. These mantles provide maximum surface temperature of 450 degree C working on 230 volts AC single phase.

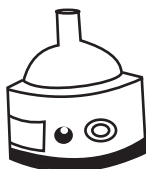

407

**HEATING MANTLES SINGLE SIZE**

Cat No.	Cap.	Watts	Price
407/1	250 ml	150	2200.00
407/2	500 ml	200	2600.00
407/3	1 Lt.	300	3000.00
407/4	2 Lt.	400	3800.00
407/5	3 Lt.	450	4895.00
407/6	5 Lt.	600	5295.00
407/7	10 Lt.	2 x 600	7660.00
407/8	20 Lt.	3 x 600	12300.00
407/9	50 Lt.	6 x 600	28495.00





**408. DESICCATORS NON-VACUUM HARD BOROSILICATE GLASS**

Used for storage of hydrogeoscopic corrosive & oxidising material or metallurgical chemical & biological specimens.

It has 2 parts of a chamber and a lid the flange of both parts are well ground to form a leak free sliding seal. The upper portion has 2 compartments, upper portion is used for storage of materials or specimen and its lower portion is used to load dehydrated active silica gel or any suitable desiccant which absorbs water vapour readily and maintains chamber atmosphere at low humidity level.

Cat. No.	Approx. Flange ID mm	Price
408/1	100	6500.00
408/2	150	8000.00
408/3	200	9500.00
408/4	250	12000.00
408/5	300	14000.00



408

**409. DESICCATOR VACUUM HARD BOROSILICATE GLASS**

It has a provision to evaporate the entire chamber to hold 20 degree of mercury over 24 hours of period and even better. This is improved version of the plain desiccator. In these desiccators, materials can be stored without contamination for long duration.

Cat. No.	Approx. Flange ID mm	Price
409/1	150	9500.00
409/2	200	10500.00
409/3	250	13000.00
409/4	300	21000.00



409

410. Vacuum gauge working on principle of mecleod tilting type fitted on a heavy metallic stand with stout plastic cover and auto levelling screw range 10mm to 0.01 mm and 1mm, 0.001 mm with tripple distilled mercury. The complete apparatus is vacuum tested by us for any micro leaks with instruction manual

14895.00

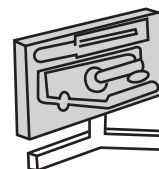

410



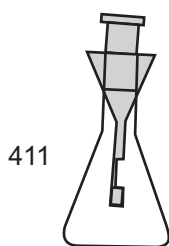

411

**411. FLASKS COMBUSTION SCHOINGER**

(Oxygen flask) cap. 500 ml. with B24 stopper and platinum wire gauge sample carrier weighing approx. 1.5 gm **48000.00**

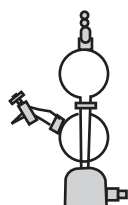

412

**412. GAS GENERATOR KIPPS HEAVY TYPE**

Cat No.	Cap. ml.	Price
412/1	250	7495.00
412/2	500	8295.00
412/3	1000	10895.00
412/4	2000	28495.00

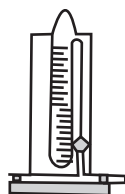

413

**413. MANOMETER BENNERT TYPE**

Anchutz with 120-0-120 mm scale The glass parts are made from heavy wall tubings and are mounted on stand **6895.00**

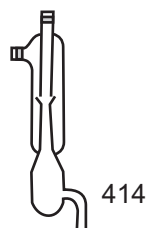

414

<b>414. A. FILTER PUMP COLLEGE PATTERN</b>	<b>645.00</b>
<b>B. FILTER PUMP HEAVY DUTY</b>	<b>1095.00</b>





**415. GAS SAMPLING TUBES STRAIGHT  
CAPILLARY BORE GLASS STOPCOCK OR PTFE  
SCREW CAP STOPCOCK**

Cat No.	Cap. ml.	Price
415/1	125 ml	1095.00
415/2	250 ml	1845.00
415/3	500 ml	2445.00
415/4	1000 ml	3695.00



**416. GAS SAMPLING TUBE 3 WAY CAPILLARY DOUBLE  
BORE GLASS STOPCOCK**

Cat No.	Cap. ml.	Price
416/1	125	2895.00
416/2	250	3295.00
416/3	500	4095.00
416/4	1000	5895.00

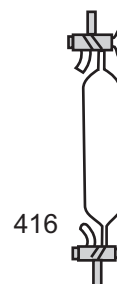

**417. AMMONIA CONDENSER WITH BOTTOM OUTLET CONE  
UNSILVERED DOUBLE WALLED WITH SIDE NOZZLE.**

Cat No.	I.D. mm	Length mm	Cone	Price
417/1	50	250	24/29	7300.00
417/2	70	250	24/29	8000.00
417/3	80	250	24/29	9490.00

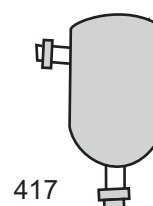





**METAL WERE**

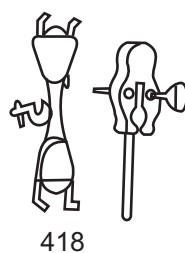

418

**418. BURETTE CLAMPS**

Cat No.	Details	Price
418/1	Clamps Single copper Oxidised Powder Coated	250.00
418/2	Clamps Double with Bosshead Powder Coated	310.00
418/3	Clamps Single with Bosshead Powder Coated	380.00



419

**419. UNIVERSAL CLAMPS CROSS PATTERN JAWS LINED WITH CORK OR ASBESTOS**

Cat No.	Details	Price
419/1	M.S. Casting Copper Oxidised	490.00
419/2	Alluminium Alloy Casting	440.00
419/3	Jumbo Size 60 - 130 mm	950.00

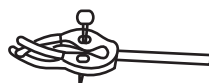

420/1

**420. THREE FINGER CLAMPS WITH RUBBER SLEEVE**

Cat No.	Details	Price
420/1	M.S. Casting Copper Oxidised	490.00
420/2	Alluminium Alloy Casting	440.00
420/3	Jumbo type double key	950.00
420/4	Coaxial Type	690.00



420/3



420/4

**421. RETORT CLAMPS**

Cat No.	Details	Price
421/1	Coaxial Type	860.00



421





## 422. BOSS HEADS

Cat No.	Details	Price
422/1	M.S. Casting Copper Oxidised 12mm	140.00
422/2	M.S. Casting Copper Oxidised 19mm	190.00
422/3	M.S. Casting Copper Oxidised 25mm	390.00



422

## 423. RETORT STAND WITH HEAVY M.S. BASE AND ROD

Cat No.	Base x Rod Size mm	Price
423/1	200 x 125 x 600	1100.00
423/2	225 x 150 x 750	1370.00
423/3	300 x 175 x 900	1690.00



423

## 424. TRIPOD STAND HEAVY DUTY

Triangular or circular 200mm height 350.00



424

## 425. RETORT RING FITTED WITH BOSS HEAD

Cat No.	Size mm	Price (P.C.)
425/1	75	240.00
425/2	100	330.00
425/3	125	390.00
425/4	150	490.00

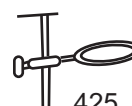

425

125





426

427

428

429

430

431

**426. BURNERS WITH HEAVY BASE END BRASS PIPE**

Cat No.	Details	Price
426/1	Bunsen Burner without control valve	660.00
426/2	Bunsen Burner with control valve	850.00
426/3	Meker Burner for wide flame with metal cap with control valve	650.00
426/4	Teclu Burner	700.00

**427. TONGS SS. ASBESTOS LINED JAWS**

Cat No.	Details	Price
427/1	Flask Tongs 200mm	490.00
427/2	Beaker tongs 250mm	490.00

**428. CRUCIBLE TONGS STAINLESS STEEL (SS)**

Cat No.	Length	Price (S.S.)
428/1	6"	290.00
428/2	8"	390.00
428/3	10"	650.00
428/4	12"	850.00
428/5	18"	1100.00
428/6	24"	1340.00

**429. SPATULLA S.S. BOTH END FLAT OR ONE END SPOON**

Cat No.	Length	Price
429/1	4"	80.00
429/2	6"	85.00
429/3	8"	120.00
429/4	10"	180.00
429/5	12"	250.00

**430. SCREW CLIPS MADE OF THICK ELECTROPLATED BRASS**

Cat No.	Size mm	Price
430/1	12	185.00
430/2	18	195.00
430/3	25	220.00

**431. TEST TUBE STAND ALLUMINIUM**

Cat No.	Size mm Holes	Price		
		24 Holes	36 Holes	48 Holes
431/1	12	510.00	640.00	790.00
431/2	15	570.00	790.00	1090.00
431/3	18	640.00	890.00	1290.00
431/4	25	890.00	1090.00	1590.00





**432 LABORATORY JACK BOX TYPE M.S.**

Cat No.	Top Size cm	Price
432/1	8 x 7	2895.00
432/2	14 x 12	3495.00
432/3	20 x 20	5695.00
432/4	25 x 25	6830.00
432/5	30 x 30	8095.00

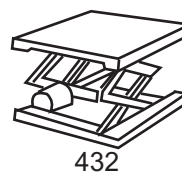

432

**433. WIRE GAUGE WITH CENTRE ASBESTOS ON BOTH SIDES**

Cat No.	Size	Price / Each
433/1	6" x 6" Plain	24.00
433/2	8" x 8" Plain	84.00
433/3	6" x 6" With Frame	56.00
433/4	8" x 8" With Frame	76.00

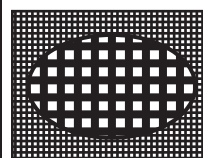

433

**434. WATCH GLASS**

Cat No.	Size	Price / Each
434/1	2"	16.00
434/2	3"	24.00
434/3	4"	40.00
434/4	6"	146.00



434

**435. BRUSHES WITH NYLON BRISTLES**

Cat No.	Type	Price / Each
435/1	Test Tube Brush	36.00
435/2	Bottle Brush	90.00
435/3	Pipette Brush	95.00
435/4	Burette Brush	150.00
435/5	Flask Brush	200.00

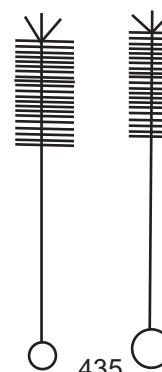

435





**PORCELAIN WARE**



**436**

**436. EVAPORATING BASIN**

Cat No.	Size mm	Price
436/1	50	56.00
436/2	75	76.00
436/3	100	144.00
436/4	150	396.00
436/5	200	790.00

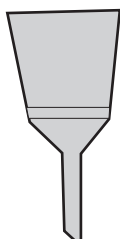

**437**

**437. BUCHNER FUNNEL**

Cat No.	Size mm	Price
437/1	35	144.00
437/2	50	176.00
437/3	75	356.00
437/4	100	410.00
437/5	150	990.00
437/6	200	1950.00
437/7	250	3000.00
437/8	300	4950.00
437/9	400	14000.00



**438**

**438. MORTAR AND PESTLE**

Cat No.	Size mm	Price
438/1	75	290.00
438/2	100	490.00
438/3	150	640.00
438/4	200	2290.00
438/5	250	6590.00
438/6	300	9590.00

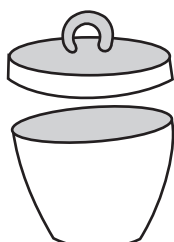

**439**

**439. CRUCIBLE WITH LID**

Cat No.	Size ml.	Price
439/1	15	76.00
439/2	25	116.00
439/3	50	196.00





**440. HIRISH FUNNEL**

Cat No.	Size mm	Price
440/1	30-50	176.00
440/2	75	244.00
440/3	100	344.00

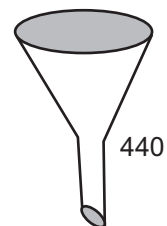

**441. GOOCH CRUCIBLE WITHOUT LID**

Cat No.	Cap. ml.	Price
441/1	25	196.00
441/2	50	296.00

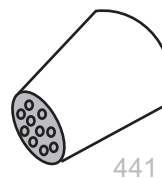



**POLYTHENE WARE**



442

**442. BEAKERS WITH RIM AND SPOUT**

Cat No.	Cap. ml.	Opaque (PP) Price
442/1	50	24.00
442/2	100	36.00
442/3	250	44.00
442/4	500	84.00
442/5	1000	176.00
442/6	2000	270.00
442/7	5000	1240.00
442/8	10000	2200.00

PLEASE MENTION BEAKER REQUIRED TPX OR PP

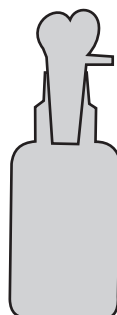

443

**443. BOTTLE DROPPING POLYTHENE T.K. TYPE**

Cat No.	Cap. ml.	Price
443/1	50 - 60	44.00
443/2	100 - 120	64.00



444

**444. WASH BOTTLE POLYTHENE**

Cat No.	Cap. ml.	Price each
444/1	125	80.00
444/2	250	120.00
444/3	500	140.00



445

**445. MEASURING CYLINDER WITH SPOUT**

Cat No.	Cap. ml.	Opaque (PP) Price
445/1	10	100.00
445/2	25	110.00
445/3	50	140.00
445/4	100	160.00
445/5	250	220.00
445/6	500	390.00
445/7	1000	650.00
445/8	2000	1400.00





**446. REAGENT BOTTLE SCREW CAP NARROW MOUTH OR WIDE MOUTH**

Cat No.	Cap. ml	Price
446/1	30	18.00
446/2	60	24.00
446/3	125	30.00
446/4	250	40.00
446/5	500	50.00
446/6	1000	70.00
446/7	2000	95.00



**447. DESICCATOR PLAIN**

Cat No.	Size	Price
447/1	6"	3190.00
447/2	8"	6095.00
447/3	10"	8095.00
447/4	12"	12895.00



**448. DESICCATOR VACUUM**

Cat No.	Size	Price
448/1	6"	4795.00
448/2	8"	8195.00
448/3	10"	10195.00
448/4	12"	16495.00



**449. FUNNELS WITH FINE FILTER DISC**

Cat No.	Size	Price
449/1	2 - 2.1/2"	22.00
449/2	3"	40.00
449/3	4"	60.00
449/4	6"	90.00
449/5	8"	200.00
449/6	70 mm Buchner	440.00
449/7	110 mm Buchner	596.00



**450. FLASK CONICAL POLYPROPLENE**

Cat No.	Cap. ml.	Price
450/1	100	122.00
450/2	250	184.00
450/3	500	170.00

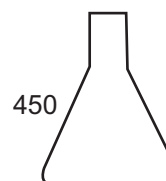



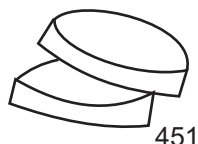

451

**451. PETRI DISH STERILE GENERAL PURPOSE**

Cat No.	Size mm	Opaque (PP) Price
451/1	35	36.00
451/2	60	44.00
451/3	90	56.00

PLEASE MENTION DISH REQUIRED "PP" OR "TPX"

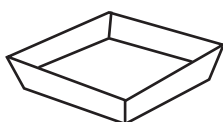

452

**452. TRAYS RIGID RECTANGULAR**

Cat No.	Size	Price
452/1	6" x 8"	350.00
452/2	10" x 12"	400.00
452/3	13" x 16"	450.00





**RUBBER PRODUCTS**

**453. RUBBER TUBINGS SUPERIOR EXTRA SOFT QUALITY FOR LABORATORY USE**

Cat No.	Bore mm	W.T.mm	Price/Mt
453/1	5.0	1.5	55.00
453/2	6.0	1.5	70.00
453/3	8.0	1.5	80.00
453/4	9.5	2.0	126.00
453/5	12.7	2.3	186.00



453

EACH ROLL AVAILABLE FOR 10 MT. ONLY (MINIMUM)

**454. PRESSURE TUBINGS SUPERIOR SOFT QUALITY FOR LABORATORY USE**

Cat No.	Bore mm	W.T.mm	Price/Mt
454/1	5.0	3.1	140.00
454/2	6.0	3.1	160.00
454/3	8.0	3.1	196.00
454/4	9.5	3.1	244.00
454/5	12.7	4.5	296.00



454

EACH ROLL AVAILABLE FOR 10 MT ONLY (MINIMUM)

**455. PRESSURE RUBBER TUBING GREEN FOR LPG USE**

Cat No.	Bore mm	W.T.mm	Price/Mt.
455/1	6.4	3.2	216.00
455/2	7.0	3.5	296.00



455

EACH ROLL AVAILABLE OF 10 MT ONLY (MINIMUM)



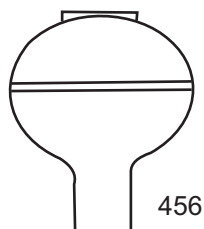

### 456. PIPETTE BULB RUBBER

Cat No.	Cap. ml	Price
456/1	2-3	30.00
456/2	5	40.00
456/3	10	55.00
456/4	20	70.00
456/5	25	75.00
456/6	50	130.00

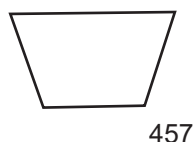

### 457. RUBBER CONE ADAPTER FOR CRUCIBLES

Cat No.	Size	Price
457/1	Small	44.00
457/2	Medium	60.00
457/3	Big	80.00



### 458. HAND GLOVES

Cat No.	Type	Price
458/1	Surgical White	36.00
458/2	Industrial Red	490.00
458/3	Asbestos White	750.00
458/4	Super Nitril	350.00
458/5	Dispesible Plastic	250.00

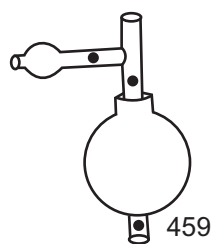

### 459. RUBBER BELLOW / VAQUAPET

Cat No.	Type	Price
459/1	Single Bellow	190.00
459/2	Double Bellow with net	370.00
459/3	Vaquepet Small	330.00
459/4	Vaquepet Big	440.00





**460. PIPETTE TEATS RUBBER**

Cat No.	Size	Price/Each
460/1	Small rubber conical	14.00
460/2	Small Latex	16.00
460/3	Big Latex	26.00



460

**461. LATEX SURGICAL TUBING**

Cat No.	I.D.mm	O.D.mm	Rate / Yard
461/1	2.5	5	36.00
461/2	3	7	44.00
461/3	4	8	56.00
461/4	6	12	150.00
461/5	8	14	190.00
461/6	10	16	220.00
461/7	12	18	300.00



461

**462. PVC TRANSPARENT TUBING SUPERIOR QUALITY**

Cat No.	I.D.mm	W.T.mm	Rate / Mt
462/1	4.5	1.5	44.00
462/2	6.3	1.5	56.00
462/3	8.0	1.5	65.00
462/4	9.5	2.3	75.00
462/5	12.7	2.3	95.00
462/6	15.8	2.3	136.00



462

EACH ROLL OF 30 MTR. ONLY.

**463. TRANSPARENT SILICON RUBBER TUBING**

Cat No.	I.D. mm	O.D. mm	Rate / Mt
463/1	2	4	150.00
463/2	3	5	150.00
463/3	4	6	250.00
463/4	6	9	300.00
463/5	8	11	380.00
463/6	10	14	650.00
463/7	12	18	1050.00



463





THERMOMETERS																																														
<p>464</p>	<p><b>464. CHEMICAL THERMOMETERS - MERCURY IN GLASS</b> TOTAL LENGTH 25 TO 30 CMS. IMMERSION LENGTH 76 MM</p> <table border="1"> <thead> <tr> <th>Cat No.</th> <th>Range</th> <th>Sub Div.</th> <th>Price (SP) Superior</th> <th>Price (GP) General</th> </tr> </thead> <tbody> <tr> <td>464/1</td> <td>0 to 50<sup>o</sup>C</td> <td>0.5<sup>o</sup>C</td> <td>370.00</td> <td>210.00</td> </tr> <tr> <td>464/2</td> <td>10 to 100<sup>o</sup>C</td> <td>1<sup>o</sup>C</td> <td>370.00</td> <td>230.00</td> </tr> <tr> <td>464/3</td> <td>0 to 150<sup>o</sup>C</td> <td>1<sup>o</sup>C</td> <td>420.00</td> <td>230.00</td> </tr> <tr> <td>464/4</td> <td>0 to 250<sup>o</sup>C</td> <td>1<sup>o</sup>C</td> <td>420.00</td> <td>250.00</td> </tr> <tr> <td>464/5</td> <td>0 to 360<sup>o</sup>C</td> <td>2<sup>o</sup>C</td> <td>470.00</td> <td>250.00</td> </tr> <tr> <td>464/6</td> <td>-50 to 50 Red</td> <td>1<sup>o</sup>C</td> <td>345.00</td> <td>330.00</td> </tr> <tr> <td>464/7</td> <td>-50 to 100 Red</td> <td>1<sup>o</sup>C</td> <td>345.00</td> <td>390.00</td> </tr> <tr> <td>464/8</td> <td>-100+50-100 Red</td> <td>1<sup>o</sup>C</td> <td>345.00</td> <td>410.00</td> </tr> </tbody> </table>	Cat No.	Range	Sub Div.	Price (SP) Superior	Price (GP) General	464/1	0 to 50 <sup>o</sup> C	0.5 <sup>o</sup> C	370.00	210.00	464/2	10 to 100 <sup>o</sup> C	1 <sup>o</sup> C	370.00	230.00	464/3	0 to 150 <sup>o</sup> C	1 <sup>o</sup> C	420.00	230.00	464/4	0 to 250 <sup>o</sup> C	1 <sup>o</sup> C	420.00	250.00	464/5	0 to 360 <sup>o</sup> C	2 <sup>o</sup> C	470.00	250.00	464/6	-50 to 50 Red	1 <sup>o</sup> C	345.00	330.00	464/7	-50 to 100 Red	1 <sup>o</sup> C	345.00	390.00	464/8	-100+50-100 Red	1 <sup>o</sup> C	345.00	410.00
Cat No.	Range	Sub Div.	Price (SP) Superior	Price (GP) General																																										
464/1	0 to 50 <sup>o</sup> C	0.5 <sup>o</sup> C	370.00	210.00																																										
464/2	10 to 100 <sup>o</sup> C	1 <sup>o</sup> C	370.00	230.00																																										
464/3	0 to 150 <sup>o</sup> C	1 <sup>o</sup> C	420.00	230.00																																										
464/4	0 to 250 <sup>o</sup> C	1 <sup>o</sup> C	420.00	250.00																																										
464/5	0 to 360 <sup>o</sup> C	2 <sup>o</sup> C	470.00	250.00																																										
464/6	-50 to 50 Red	1 <sup>o</sup> C	345.00	330.00																																										
464/7	-50 to 100 Red	1 <sup>o</sup> C	345.00	390.00																																										
464/8	-100+50-100 Red	1 <sup>o</sup> C	345.00	410.00																																										
<p>465</p>	<p><b>465. PRECISION THERMOMETERS - MERCURY IN GLASS ENGRAVED ON STEM</b></p> <table border="1"> <thead> <tr> <th>Cat No.</th> <th>Ranges</th> <th>Length mm</th> <th>Sub. Div.</th> <th>Price</th> </tr> </thead> <tbody> <tr> <td>465/1</td> <td>0 to 50<sup>o</sup>C</td> <td>300</td> <td>1/5<sup>o</sup>C</td> <td>740.00</td> </tr> <tr> <td>465/2</td> <td>0 to 50<sup>o</sup>C</td> <td>450</td> <td>1/10<sup>o</sup>C</td> <td>840.00</td> </tr> <tr> <td>465/3</td> <td>0 to 110<sup>o</sup>C</td> <td>600</td> <td>1/10<sup>o</sup>C</td> <td>1040.00</td> </tr> <tr> <td>465/4</td> <td>0 to 11<sup>o</sup>C</td> <td>450</td> <td>1/5<sup>o</sup>C</td> <td>990.00</td> </tr> </tbody> </table>	Cat No.	Ranges	Length mm	Sub. Div.	Price	465/1	0 to 50 <sup>o</sup> C	300	1/5 <sup>o</sup> C	740.00	465/2	0 to 50 <sup>o</sup> C	450	1/10 <sup>o</sup> C	840.00	465/3	0 to 110 <sup>o</sup> C	600	1/10 <sup>o</sup> C	1040.00	465/4	0 to 11 <sup>o</sup> C	450	1/5 <sup>o</sup> C	990.00																				
Cat No.	Ranges	Length mm	Sub. Div.	Price																																										
465/1	0 to 50 <sup>o</sup> C	300	1/5 <sup>o</sup> C	740.00																																										
465/2	0 to 50 <sup>o</sup> C	450	1/10 <sup>o</sup> C	840.00																																										
465/3	0 to 110 <sup>o</sup> C	600	1/10 <sup>o</sup> C	1040.00																																										
465/4	0 to 11 <sup>o</sup> C	450	1/5 <sup>o</sup> C	990.00																																										
<p>466</p>	<p><b>466. OVEN / INCUBATOR THERMOMETER 'L' SHAPED</b> Size: 200mm x 200 mm : Mercury in Glass</p> <table border="1"> <thead> <tr> <th>Cat No.</th> <th>Rang</th> <th>Division</th> <th>Price</th> </tr> </thead> <tbody> <tr> <td>466/1</td> <td>100<sup>o</sup>C</td> <td>1<sup>o</sup>C</td> <td>690.00</td> </tr> <tr> <td>466/2</td> <td>250<sup>o</sup>C</td> <td>2<sup>o</sup>C</td> <td>790.00</td> </tr> <tr> <td>466/3</td> <td>360<sup>o</sup>C</td> <td>2<sup>o</sup>C</td> <td>990.00</td> </tr> </tbody> </table>	Cat No.	Rang	Division	Price	466/1	100 <sup>o</sup> C	1 <sup>o</sup> C	690.00	466/2	250 <sup>o</sup> C	2 <sup>o</sup> C	790.00	466/3	360 <sup>o</sup> C	2 <sup>o</sup> C	990.00																													
Cat No.	Rang	Division	Price																																											
466/1	100 <sup>o</sup> C	1 <sup>o</sup> C	690.00																																											
466/2	250 <sup>o</sup> C	2 <sup>o</sup> C	790.00																																											
466/3	360 <sup>o</sup> C	2 <sup>o</sup> C	990.00																																											





**467. IMMERSION THERMOMETER MERCURY IN GLASS ENGRAVED ON STEM**

Cat No.	Range	Immersion Length cm	Total Length cm	Price
467/1	110 <sup>0</sup> C	15	45	740.00
467/2	250 <sup>0</sup> C	15	45	740.00
467/3	360 <sup>0</sup> C	15	45	740.00
467/4	110 <sup>0</sup> C	30	60	890.00
467/5	250 <sup>0</sup> C	30	60	940.00
467/6	360 <sup>0</sup> C	30	60	990.00

BIGGER IMMERSION LENGTH PRICES ON REQUEST

**468. GROUND GLASS JOINT THERMOMETER WITH CONE AT BOTTOM TOTAL LENGTH 35 CM, INCLUSION TYPE**

Cat No.	Range	Cone Size	Sub. Div.	Price
468/1	50 <sup>0</sup> C	B - 10	1 <sup>0</sup> C	690.00
468/2	110 <sup>0</sup> C	B - 14	1 <sup>0</sup> C	790.00
468/3	250 <sup>0</sup> C	B - 14	1 <sup>0</sup> C	1090.00
468/4	360 <sup>0</sup> C	B - 14	2 <sup>0</sup> C	1090.00
468/5	100 <sup>0</sup> C	B - 19	1 <sup>0</sup> C	1090.00
468/6	250 <sup>0</sup> C	B - 19	1 <sup>0</sup> C	1140.00
468/7	360 <sup>0</sup> C	B - 19	2 <sup>0</sup> C	1140.00

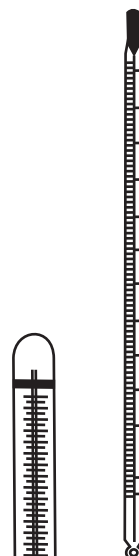

467

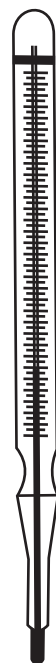

468





469

**469. FILTER PAPER**

FILTER PAPER A-1 grade of the best standard now available at reasonable prices. These are widely used for general analysis and laboratory filtration having medium retention.

**469. FILTER PAPER CIRCLE**

Cat No.	Grade	Size/cm	Price
469/1	1	4.7	240.00
469/2	1	5.5	270.00
469/3	1	7.0	340.00
469/4	1	9.0	390.00
469/5	1	11.00	440.00
469/6	1	12.5	490.00
469/7	1	15.00	540.00
469/8	1	18.5	770.00
469/9	1	20	870.00
469/10	1	24	485.00
469/11	1	30	545.00
469/12	1	32	595.00
469/13	1	40	945.00

**470. FILTER / BUTTER PAPER SHEET**

Cat No.	Grade	Size cms.	Price
470/1	1	46 x 57 (100)	1945.00



**MISCELLANEOUS ITEMS****471. BUCHI CLIPS PLASTIC**

Cat No.	Joints	Price
471/1	14/23	190.00
471/2	19/26	190.00
471/3	24/29	240.00
471/4	29/32	290.00

**472. GLASS SYRINGE**

Cat No.	Cap.	Price
472/1	1 ml	210.00
472/2	2ml	190.00
472/3	5ml	210.00
472/4	10ml	200.00
472/5	20ml	390.00

**473. S.S. NEEDLES FOR SYRINGE**

Cat No.	Gauge	Length	Price
473/1	18	6"	
473/2	18	8"	
473/3	18	10"	
473/4	18	12"	
473/5	18	16"	
473/6	18	18"	
473/7	20	6"	
473/8	20	8"	
473/9	20	10"	
473/10	20	12"	
473/11	20	16"	
473/12	20	18"	

(Pack of 10 Nos, Price on Request)







## 474. CANNULA

Cat No.	Gauge	Length	Price
474/1	16		16 inch
474/2	18		18 inch
474/3	18		24 inch
474/4	20		18 inch
474/5	20		24 inch
474/6	20		14 inch

PRICE ON REQUEST

## 475. NEOPRINE RUBBER BASE RING FOR R.B. FLASK

Cat No.	Cap. ml.	Price
475/1	25-50-100	290.00
475/2	150 - 250	390.00
475/3	500 - 1000	490.00
475/4	2000	590.00
475/5	3000 - 5000	900.00

## 476. HIGH VACUUM GREASE FOR JOINTS

Cat No.	Pack (grams)	Price
476/1	50	190.00

## 477. RASCHING RINGS

Cat No.	Dia mm x Length mm	Price / Kg.
477/1	6 x 6 (Neutral)	1490.00
477/2	10 x 10 (Neutral)	1390.00
477/3	6 x 6 (Borosilicate)	4990.00
477/4	10 x 10 (Borosilicate)	4990.00

## 478. GLASS BEADS (NEUTRAL)

Cat No.	Dia mm x Length mm	Price / Kg.
478/1	3-4	945.00
478/2	5-6	895.00
478/3	6-8	895.00

## 479. PARAFILM

Cat No.	Size	Packing	Price / Pack
479/1	2" x 250'	1 Roll	1995.00
479/2	4" x 125'	1 Roll	1795.00

Cat. No.	SEPTA	Price
480/1	B/14	130.00
480/2	B/19	160.00
480/3	B/24	190.00
480/4	B/29	215.00





### **PRICES:**

All prices printed and quoted are subject to alteration without notice, 'BENGAL' reserve the right to invoice goods at price ruling at the date of despatch.

### **QUOTATIONS & INVOICE:**

Quotation are subject to confirmation on receipt of order and the right is reserved to amend any accidental errors and/or omissions on quotation or invoices.

### **PACKING & FORWARDING:**

All glass items are packed in standard strong Card Board Boxes. Any special packing - wooden packing etc. and forwarding charges for outstations will be charged extra. We do not undertake any responsibility for breakage unless specifically arranged by us.

### **DELIVERY:**

While all care is taken to adhere to the delivery date, no liability can be accepted in case of non-delivery or delivery delayed due to any circumstances beyond our control. Deliveries offered Ex-stock are subject to the goods being sold at the date of receipt of customer orders.

### **RESPONSIBILITY:**

Our responsibility is limited to the supply of goods in the kind quality ordered and all consequential or resulting liability is expressly excluded. We cannot accept responsibility for any accident caused by its use no matter the circumstances.

### **REPAIRS:**

We are nor responsible for damage to article sent to use for repair or examination, nor for accidental damage to glass apparatus in the course of repairs.

### **TAX:**

VAT and Central Sales Tax shall be extra as applicable as per Government rules, any variation in taxes and other levies imposed by Government authorities shall be at your account.

### **PAYMENT:**

All payment terms are nett against delivery, for outstation orders documents are through Bank only.

All disputes shall be solved amicably subject to Bombay Jurisdiction.

All illustration and specification are subject to alteration without notice they are not binding and are only intended to represent generally the type of goods offered owing in



**MISCELLANEOUS ITEM**

1. **Electronic Balances** : (Mettler, Citizen, Simatzu, Denver etc)
2. **Remi Products** : (Laboratory Stirrer, Magnetic Stirrer Cabinet, Centrifuges, Shakers, Freezers)
3. **Microlitres Syringes** : (Hamilton, S.G.E., Agilent etc)
4. **Digital Burettes & Dispenser** : (Brand, Thermo, Eppendorf etc.)
5. **Ph Meter** : (Hanna, Eutech, Tushniwal, Meter etc.)
6. **Filter Paper** : (Whatman, Millipore, Sartorius etc.)
7. **Test Sieves** : (Jayant Scientific Industries)
8. **Micro Pipettes** : (Eppendorf, Mettler, Thermo, ,Brand etc)
9. **Tarson Products**
10. **G.C. & H.P.C.L.** : (Vials, Caps & Septas)
11. **Veego Instruments** : (Karl Fischer Titration App, Precision Melting Point App. etc.)
12. **Quartz cell / Glass cell** : (For Spectrophotometer & Flourimeter)
13. **Ultrasonic Bath**
14. **Rotary Vacuum Evaporator** : (Superfit Brand)
15. **Digital Hugrometers**
16. **Glass / Disposable Syringes**
17. **Hand Gloves (Any Types)**
18. **Silicon Oil**

**PRICE ON REQUEST**

142



# PEPTIDE FLASK SINTERED REACTION VESSEL CYLINDRICAL

TOP LID NOZZLES AS PER SPECIFICATION TO PARTY

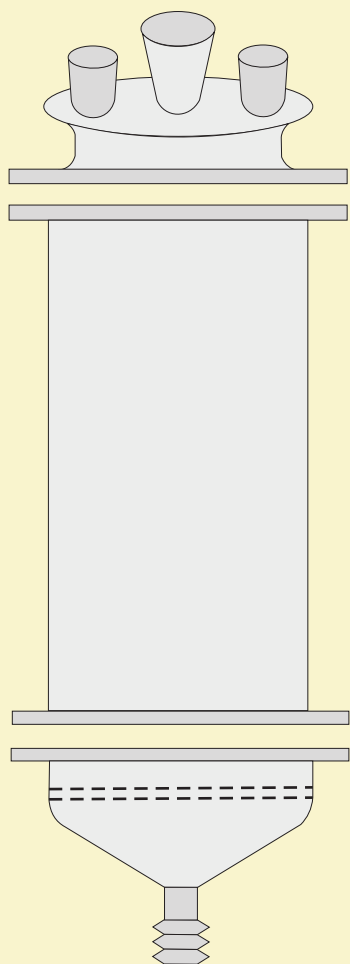

**THREE WAY  
STOPCOCK**

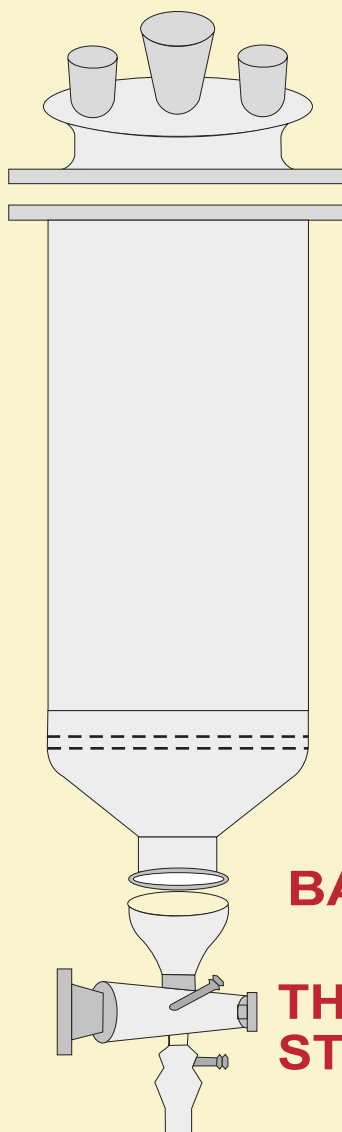

**BALL TYPE**

**THREE WAY  
STOPCOCK**

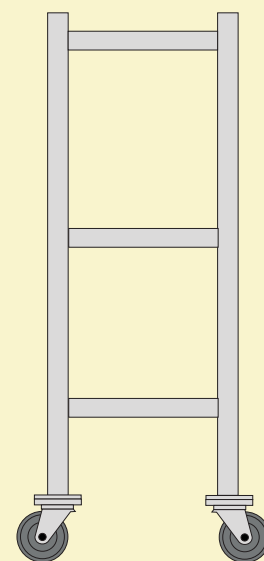

**S.S. Stand  
with Wheel Type**

**NOTE : CAP. ARE 100 ML. TO 30 LTRS. AVAILABLE**

**Specification : Peptide Flask Sintered Reaction Vessel Cylindrical  
With Bottom Out Let S/35 Ball Removable Teflong  
Plug Bennert Type Stopcock With S/35 Cup Top  
G/2 Sintered Disc (IMPORTED) & Ground Lid as per  
Specification With S.S. Stand with Wheel Type**



## Request

While placing orders please quote our  
Price-List

A



# PEPTIDE FLASK SINTERED REACTION VESSEL CYLINDRICAL

TOP LID NOZZLES AS PER SPECIFICATION TO PARTY

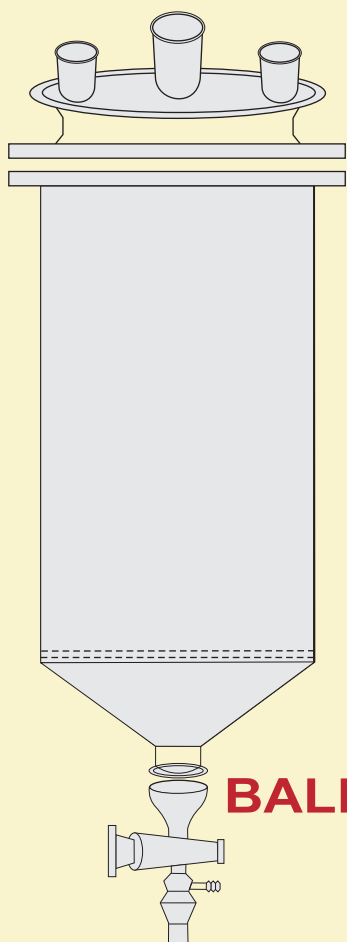

**THREE WAY  
STOPCOCK**

**BALL TYPE**



**THREE WAY  
STOPCOCK**

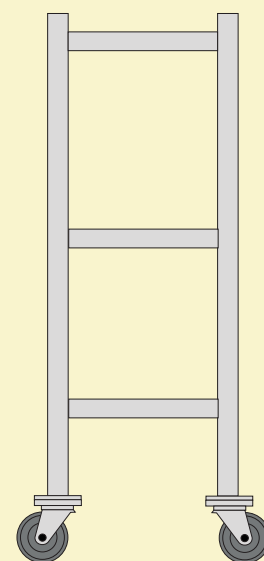

**S.S. Stand  
with Wheel Type**

**NOTE : CAP. ARE 100 ML. TO 25 LTRS. AVAILABLE**

**Specification : Peptide Flask Sintered Reaction Vessel Cylindrical  
With Bottom Out Let S/35 Ball Removable Teflong  
Plug Bennert Type Stopcock With S/35 Cup Top  
G/2 Sintered Disc (IMPORTED) & Ground Lid as per  
Specification With S.S. Stand with Wheel Type**



## Request

While placing orders please quote our  
Price-List

B



## S.S.316 & S.S.304 SAMPLER

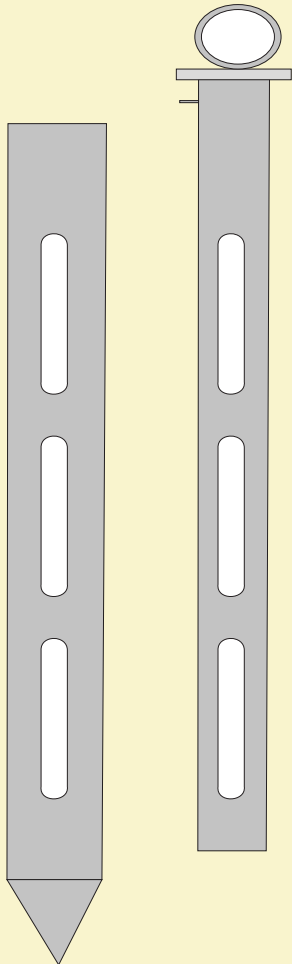

**3 FEET LONG**

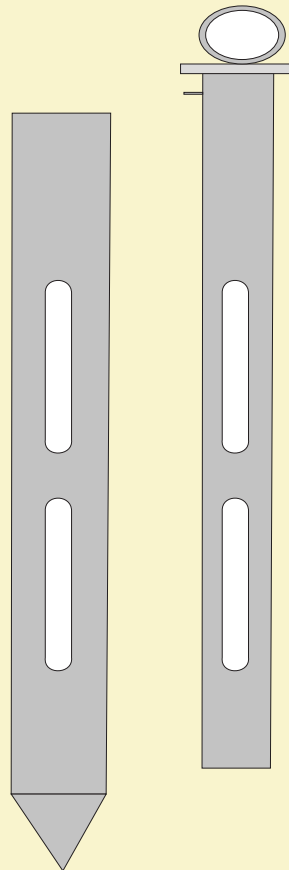

**2 FEET LONG**



## Request

While placing orders please quote our  
Price-List serial number.

D



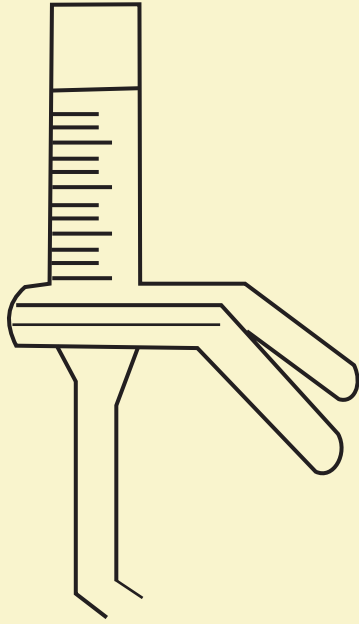

**MICRO FILTER ASSEMBLY - VACUUM FILTER  
HOLDERS WITH GRADUATED CUP SINTERED  
BASE AND CLAMP**

Disc. size mm	Price
13	6000.00
25	7000.00
47	9000.00

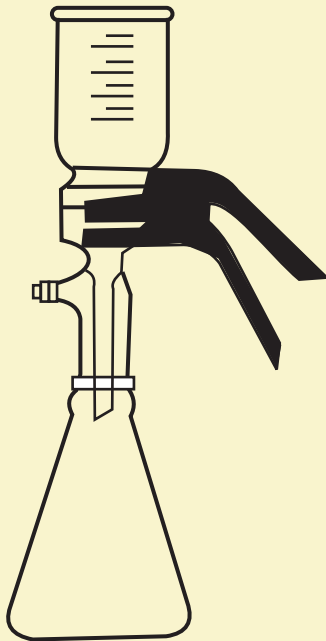

**MICRO FILTER ASSEMBLY - VACUUM FILTER  
HOLDER WITH GRADUATED CUP, SINTERED BASE  
WITH GROUP JOINT, CLAMP AND CONE FLASK**

Disc. Size mm	Flask Size mm	Price
25	1000	9500.00
47	1000	11500.00



**Request**

While placing orders please quote our  
Price-List

B

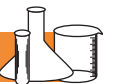

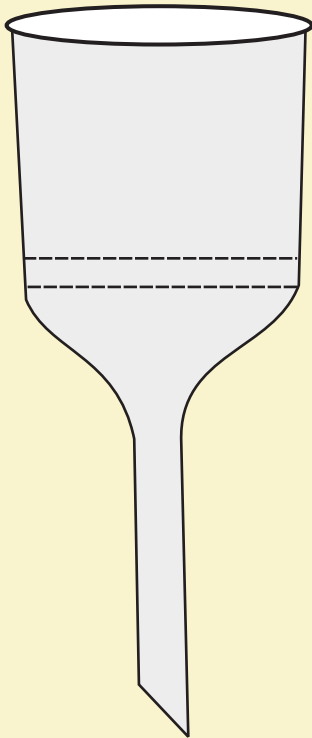

**BUCHNER FILTER FUNNELS WITH SINTERED DISC  
G1, G2, G3 & G4**

Cap. ml.	Disc Dia mm	Price
35	30	449.00
80	40	650.00
200	65	1400.00
500	90	2500.00
1000	120	5200.00
2000	140	8000.00
3000	165	10500.00
5000	230	15500.00



**Request**

While placing orders please quote our  
Price-List

**B**

